

Operating Manual

# **Ezi-STEP<sup>®</sup>**

## **Micro Stepping System**

# **MINI**



*Fast, Accurate, Smooth Motion*

[www.fastech.co.kr](http://www.fastech.co.kr)

**Table of Contents**

- 1. Precautions** . . . . . 1
- 2. Main characteristics** . . . . . 5
- 3. Drive Specification and Dimension** . . . . . 7
  - 3.1 Drive Specification . . . . . 7
  - 3.2 Drive Dimension . . . . . 8
- 4. Motor Specification and Size** . . . . . 9
  - 4.1 BM-20 Series . . . . . 9
  - 4.2 BM-25 Series . . . . . 10
  - 4.3 BM-28 Series . . . . . 11
  - 4.4 BM-35 Series . . . . . 12
  - 4.5 BM-42 Seires . . . . . 13
  - 4.6 BM-56 Seires . . . . . 14
  - 4.7 Motor Torque Characteristics . . . . . 15
- 5. Installation and Cabling** . . . . . 15
  - 5.1 Notes on Installation . . . . . 16
  - 5.2 Connection Diagram . . . . . 17
- 6. Setting and Operating** . . . . . 17
  - 6.1 Status Monitor LED . . . . . 18
  - 6.2 Pulse Input Selection Switch . . . . . 19
  - 6.3 Rotational Direction Selection Switch . . . . . 19
  - 6.4 Resolution Selection Switch . . . . . 20
  - 6.5 STOP Current Selection Switch . . . . . 20
  - 6.6 Input/Output Connection Connector(CN1) . . . . . 21
  - 6.7 Motor Connector(CN3) . . . . . 21
  - 6.8 Power Connector(CN4) . . . . . 22
- 7. System Configuration** . . . . . 22
  - 7.1 Option . . . . . 23
- 8. Control Signal Input/Output Description** . . . . . 23
  - 8.1 Input signal . . . . . 24
  - 8.2 Output signal . . . . . 25
- Appendix** . . . . . 25
  - Extension cable for Motor . . . . . 26
  - Connector . . . . . 27

## ※ Before operation ※

- Thank you for your purchasing Ezi-STEP MINI.
- Ezi-STEP MINI is an all-in-one Unit. For high-speed and high-precision drive of a stepping motor, Ezi-STEP MINI is a unique drive that adopts a new control scheme owing to an on-board high-performance 32bit digital signal processor.
- This manual describes handling, maintenance, repair, diagnosis and troubleshooting of Ezi-STEP MINI.
- Before operating Ezi-STEP MINI, thoroughly read this manual.
- After reading the manual, keep the manual near the Ezi-STEP MINI so that any user can read the manual whenever needed.

## 1. Precautions

### ◆ General Precautions

- Contents of this manual are subject to change without prior notice for functional improvement, change of specifications or user's better understanding.  
Thoroughly read the manual provided with the purchased Ezi-STEP MINI.
- When the manual is damaged or lost, please contact with Fastech's agents or our company at the address on the last page of the manual.
- Our company is not responsible for a product breakdown due to user's dismantling for the product, and such a breakdown is not guaranteed by the warranty.

### ◆ Put the Safety First

- Before installation, operation and repairing the Ezi-STEP MINI, thoroughly read the manual and fully understand the contents. Before operating the Ezi-STEP MINI please, understand the mechanical characteristics of the Ezi-STEP MINI and related safety information and precautions.
- This manual divides safety precautions into **Attention** and **Warning**.



#### **Attention :**

If user does not properly handle the product, the user may seriously or slightly injured and damages may occur in the machine.



#### **Warning :**



If user does not properly handle the product, a dangerous situation (such as an electric shock) may occur resulting in deaths or serious injuries.

- Although precaution is only a **Attention**, a serious result could be caused depending on the situation. Follow safety precautions.



## ◆ Check the Product

 <b>Attention</b>	<p>Check the Product is damaged or parts are missing. Otherwise, the machine may get damaged or the user may get injured.</p>
--	---

## ◆ Installation

 <b>Attention</b>	<p>Carefully move the Ezi-STEP MINI. Otherwise the Product may get damaged or User's foot may get injured by dropping the product.</p> <p>Use non-flammable materials such as metal in the place where the Ezi-STEP MINI is to be installed. Otherwise, a fire may occur.</p> <p>When installing several Ezi-STEP MINI in a sealed place, install a cooling fan to keep the ambient temperature of the Ezi-STEP MINI as 50°C or lower. Otherwise, a fire or other kinds of accidents may occur due to overheating.</p>
 <b>Warning</b>	<p>The process of Installation, Connection, Operation, Checking and Repairing should be done with qualified person. Otherwise, a fire or other kinds of accidents may occur.</p>

## ◆ Connect Cables

 <b>Attention</b>	<p>Keep the rated range of Input Voltage for Ezi-STEP MINI. Otherwise, a fire or other kinds of accidents may occur.</p> <p>Cable connection should follow the wiring diagram. Otherwise, a fire or other kinds of accidents may occur.</p>
 <b>Warning</b>	<p>Before connecting cables, check if input power is off. Otherwise, an electric shock or a fire may occur.</p> <p>The case of the Ezi-STEP MINI is insulated from the ground of the internal circuit by the condenser. Ground the Ezi-STEP MINI. Otherwise, an electric shock or a fire may occur.</p>

## ◆ Operation



### Attention

If a protection function(alarm) occurs, firstly remove its cause and then release(alarm reset) the protection function.

If you are operating continuously without removing its cause, the machine may get damaged or the user may get injured.

Do not make Motor Free and make input signal to ON during operation.

Motor will stop and stop current will become zero. The machine may get damaged or the user may get injured.

Make all input signals to OFF before supply input voltage to Ezi-STEP MINI.

The machine may get damaged or the user may get injured by motor operation.

All parameter values are set by default factory setting value.

Change this value after reading this manual thoroughly.

Otherwise, the machine may get damaged or other kinds of accidents may occur.

## ◆ Check and Repair



### Warning

Stop supplying power to the main circuit and wait for a while before checking or repairing the Ezi-STEP MINI.

Electricity remaining in the capacitor may cause danger.

Do not change cabling while power is being supplied.

Otherwise, the user may get injured or the product may get damaged.

Do not reconstruct the Ezi-STEP MINI.

Otherwise, an electric shock may occur or the reconstructed product can not get After-Service.

## ■ Part Numbering

### Ezi-STEP-MI-20S-□

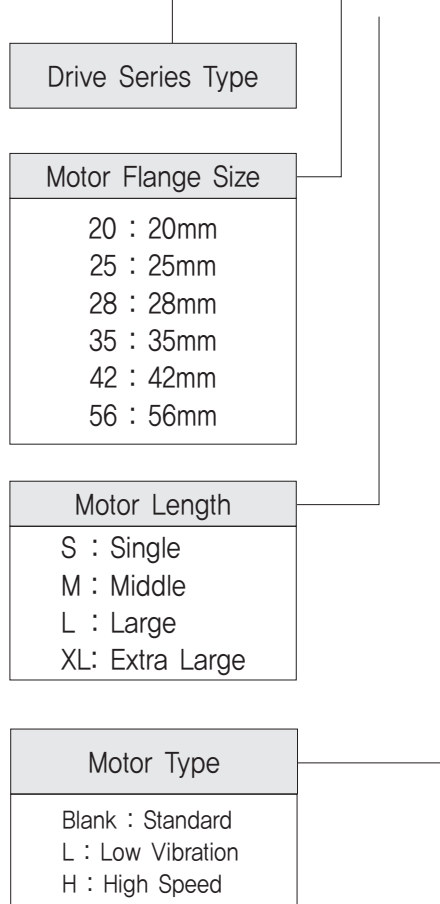

## ■ Combination List of Ezi-STEP MINI

Unit Part Number	Motor Model Number	Drive Model Number
Ezi-STEP-MI-20M	BM-20M	EzStep-MI-20M
Ezi-STEP-MI-20L	BM-20L	EzStep-MI-20L
Ezi-STEP-MI-25S	BM-25S	EzStep-MI-25S
Ezi-STEP-MI-25M	BM-225M	EzStep-MI-25M
Ezi-STEP-MI-25L	BM-25L	EzStep-MI-25L
Ezi-STEP-MI-28S	BM-28S	EzStep-MI-28S
Ezi-STEP-MI-28M	BM-28M	EzStep-MI-28M
Ezi-STEP-MI-28L	BM-28L	EzStep-MI-28L
Ezi-STEP-MI-35S	BM-35S	EzStep-MI-35S
Ezi-STEP-MI-35M	BM-35M	EzStep-MI-35M
Ezi-STEP-MI-35L	BM-35L	EzStep-MI-35L
Ezi-STEP-MI-35XL	BM-35XL	EzStep-MI-35XL
Ezi-STEP-MI-42S	BM-42S	EzStep-MI-42S
Ezi-STEP-MI-42M	BM-42M	EzStep-MI-42M
Ezi-STEP-MI-42L	BM-42L	EzStep-MI-42L
Ezi-STEP-MI-42XL	BM-42XL	EzStep-MI-42XL
Ezi-STEP-MI-56S	BM-56S	EzStep-MI-56S
Ezi-STEP-MI-56M	BM-56M	EzStep-MI-56M
Ezi-STEP-MI-56L	BM-56L	EzStep-MI-56L

## 2. Main characteristics

### 1 Sensorless Stall Detection

Detecting the loss-of-synchronization with on-board DSP(patent pending)

Ezi-STEP MINI can detect the loss-of-synchronization of a stepping motor without the addition of an external sensor. By monitoring the voltage, current, and back-emf signal, the on-board DSP estimates the current position of a rotor and enables it to detect the loss-of-synchronization (an impossible task for a conventional stepping motor drive), this allows for high-speed operation at 100% torque rating without loss-of-synchronization\*.

\*Effective only over 300 rpm

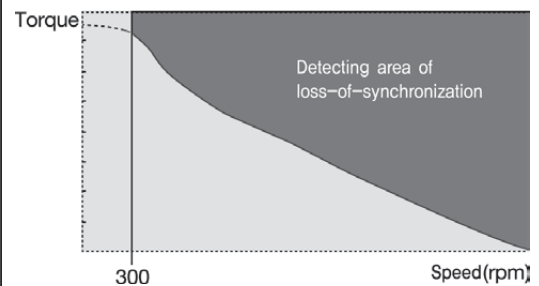

### 2 Microstep and Filtering

High precision Microstep function and Filtering (Patent pending)

The high-performance DSP operates at step resolutions of  $1.8^\circ$  up to maximum  $0.0072^\circ$  (1/250 steps) and Ezi-STEP MINI adjusts PWM control signal in every  $25\mu$  sec, which makes it possible for more precise current control, resulting in high-precision Microstep operation.

### 3 Software Damping

Vibration suppression and high-speed operation (Patent pending)

Vibration suppression and High-speed operation (Patent pending) Motor vibration is created by magnetic flux variations of the motor, lower current from the drive due to back-emf from the motor at high speeds and lowering of phase voltages from the drive.

Ezi-STEP MINI drive detects these problems and the DSP adjusts the phase of the current according to the pole position of the motor, drastically suppressing vibration. This allows the smooth operation of the motor at high speeds.

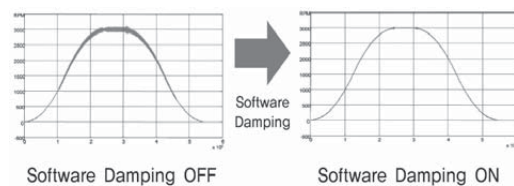

\*This is real measured speed that using 100000[pulse/rev] encoder

## **4 Drive Output Signal Monitoring**

Ezi-STEP MINI provides loss of step, run/stop, over-current, over-heat, over-voltage, power, and motor connection alarms that can be monitored by the controller and visible by a motor-mounted flashing LED indicator.

## **5 Improvement of High-Speed Driving**

Depending on the speed of a stepping motor, Ezi-STEP MINI automatically increases the supply voltage and prevents the torque lowering due to the low operating voltage to the motor caused by back-emf voltage, this enables high-speed operation. Additionally, the software damping algorithm minimizes the vibration and prevents the loss-of-synchronization at high-speed.



## 3. Drive Specification and Dimension

### 3.1 Drive Specification

Motor Model	BM-20 series	BM-25 series	BM-28 series	BM-35 series	BM-42 series	BM-42 series
Driver Model	EzStep-MI-20 series	EzStep-MI-25 series	EzStep-MI-28 series	EzStep-MI-35 series	EzStep-MI-42 series	EzStep-MI-42 series
Input Voltage	24VDC $\pm$ 10%					
Control Method	Closed loop control with 32bit DSP					
Current Consumption	Max : 500mA (Except motor current)					
Operating Condition	Ambient Temperature	In Use : 0~50°C In Storage : -20~70°C				
	Humidity	In Use : 35~85%RH (Non-Condensing) In Storage : 10~90%RH (Non-Condensing)				
	Vib. Resist.	0.5G				
Function	Rotation Speed	0~3,000rpm				
	Resolution (P/R)	500, 1000, 1600, 2000, 3200, 3600, 4000, 5000, 6400, 8000, 10000, 20000, 25000, 36000, 40000, 50000, *Default : 10,000				
	Max. Input Pulse Frequency	500KHz (Duty 50%)				
	Protection Functions	Over Current Error, Over Speed Error, Position Tracking Error, Over Load Error, Over Temperature Error, Over Regenerated Voltage Error, Motor Connect Error, Encoder Connect Error, Motor Voltage Error, Inposition Error, System Error, ROM Error, Input Voltage Error, Position Overflow Error				
	LED Display	Power, Alarm, CW Rotation, CCW Rotation				
	STOP Current	10%~100% (Set by DIP Switch) Be setted to set value of STOP Current after 0.1 second after motor stop. *Default : 50%				
	Pulse Input Method	1-Pulse/2-Pulse (Selectable with DIP switch) *Default : 2 pulse				
	Rotational Direction	CW/CCW (Selectable with DIP switch) *Default : CW				
	Speed/Position Control Command	Pulse train input				
I/O Signal	Input Signal	Alarm reset (Photocoupler input)				
	Output Signal	Alarm, Run/stop (Phhotocoupler)				

### 3.2 Drive Dimension(mm)

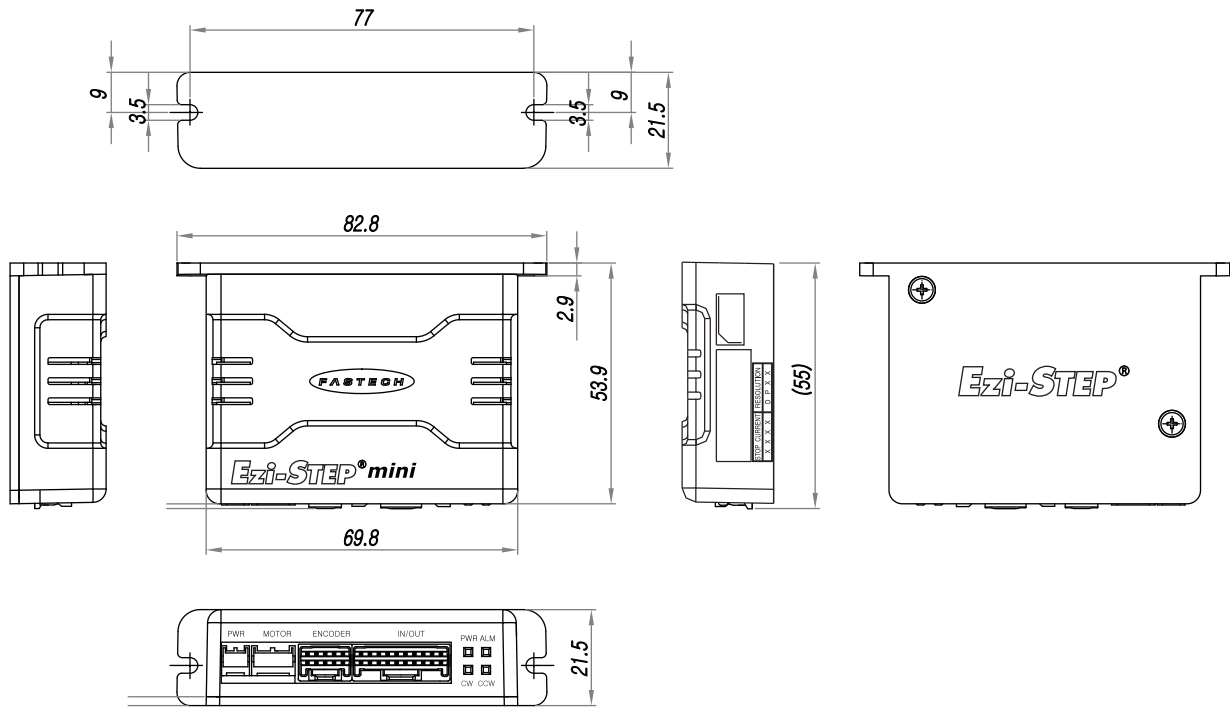

## 4. Motor specifications and Size

### 4.1 BM-20 Series

#### 4.1.1 Motor Specifications

M O D E L		UNIT	BM-20M	BM-20L
DRIVE METHOD		----	BI-POLAR	BI-POLAR
NUMBER OF PHASES		----	2	2
VOLTAGE		VDC	2.9	3.25
CURRENT per PHASE		A	0.5	0.5
RESISTANCE per PHASE		Ohm	5.8	6.5
INDUCTANCE per PHASE		mH	2.5	5.0
HOLDING TORQUE		N · m	0.013	0.025
ROTOR INERTIA		g · cm <sup>2</sup>	2.5	5.0
WEIGHTS		g	50	80
LENGTH (L)		mm	28	38
ALLOWABLE OVERHUNG LOAD (DISTANCE FROM END OF SHAFT)	3mm	N	18	18
	8mm		30	30
ALLOWABLE THRUST LOAD		N	Lower than motor weight	
INSULATION RESISTANCE		MOhm	100min. (at 500VDC)	
INSULATION CLASS		----	CLASS B (130°C)	
OPERATING TEMPERATURE		°C	0 to 55	

#### 4.1.2 Motor Dimension(mm) and Torque Characteristics

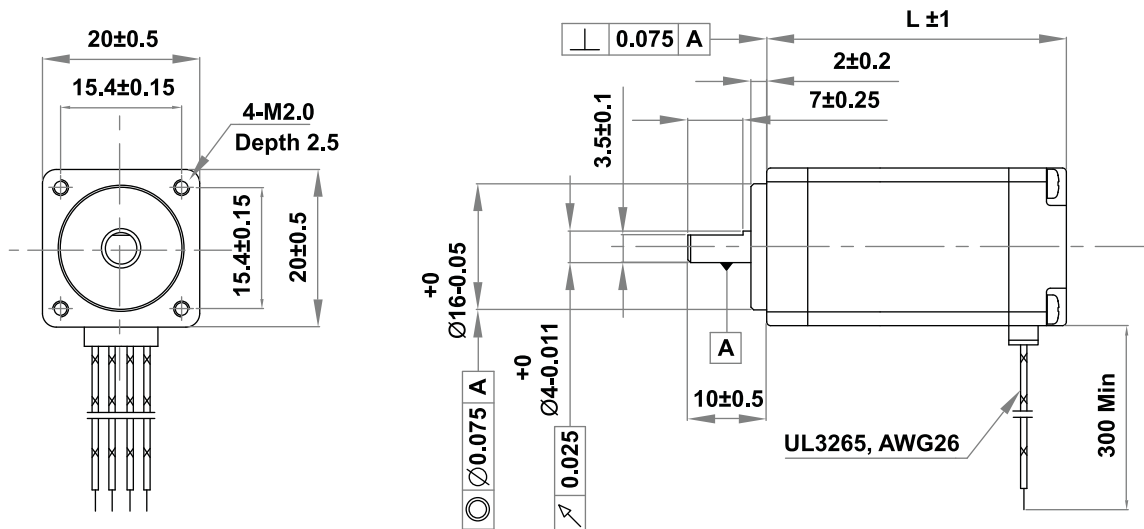

## 4.2 BM-25 Series

### 4.2.1 Motor Specifications

*Low Vibration*

M O D E L		UNIT	BM-25S	BM-25M	BM-25L
DRIVE METHOD		----	BI-POLAR	BI-POLAR	BI-POLAR
NUMBER OF PHASES		----	2	2	2
VOLTAGE		VDC	2.66	9.87	3.654
CURRENT per PHASE		A	0.7	0.21	0.63
RESISTANCE per PHASE		Ohm	3.8	47	5.8
INDUCTANCE per PHASE		mH	2.0	30	5.4
HOLDING TORQUE		N · m	0.033	0.049	0.062
ROTOR INERTIA		g · cm <sup>2</sup>	2	3	7
WEIGHTS		g	55	70	90
LENGTH (L)		mm	23.5	27.5	33
ALLOWABLE OVERHUNG LOAD (DISTANCE FROM END OF SHAFT)	3mm	N	30	30	30
	8mm		38	38	38
ALLOWABLE THRUST LOAD		N	Lower than motor weight		
INSULATION RESISTANCE		MOhm	100min. (at 500VDC)		
INSULATION CLASS		----	CLASS B (130°C)		
OPERATING TEMPERATURE		°C	0 to 55		

### 4.2.2 Motor Dimension(mm) and Torque Characteristics

• LEAD WIRE

- HOUSING : 51021-0600
- PIN : 50079-8000
- LENGHT : 300mm MIN

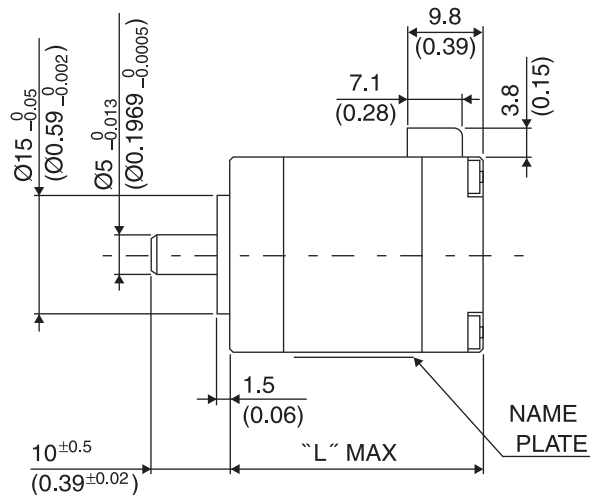
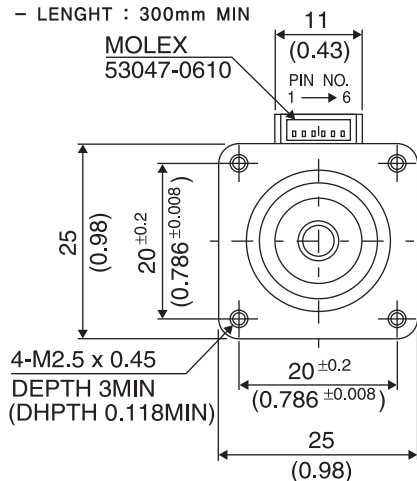

## 4.3 BM-28 Series

### 4.3.1 Motor Specifications

M O D E L		UNIT	BM-28S	BM-28M	BM-28L
DRIVE METHOD		----	BI-POLAR	BI-POLAR	BI-POLAR
NUMBER OF PHASES		----	2	2	2
VOLTAGE		VDC	3.04	3.04	3.42
CURRENT per PHASE		A	0.95	0.95	0.95
RESISTANCE per PHASE		Ohm	3.2	3.2	3.6
INDUCTANCE per PHASE		mH	2.0	5.0	5.8
HOLDING TORQUE		N · m	0.065	0.08	0.11
ROTOR INERTIA		g · cm <sup>2</sup>	9	13	18
WEIGHTS		g	110	140	200
LENGTH (L)		mm	32	45	52
ALLOWABLE OVERHUNG LOAD (DISTANCE FROM END OF SHAFT)	3mm	N	30	30	30
	8mm		38	38	38
	13mm		53	53	53
	18mm		84	84	84
ALLOWABLE THRUST LOAD		N	Lower than motor weight		
INSULATION RESISTANCE		MOhm	100min. (at 500VDC)		
INSULATION CLASS		----	CLASS B (130°C)		
OPERATING TEMPERATURE		°C	0 to 55		

### 4.3.2 Motor Dimension(mm) and Torque Characteristics

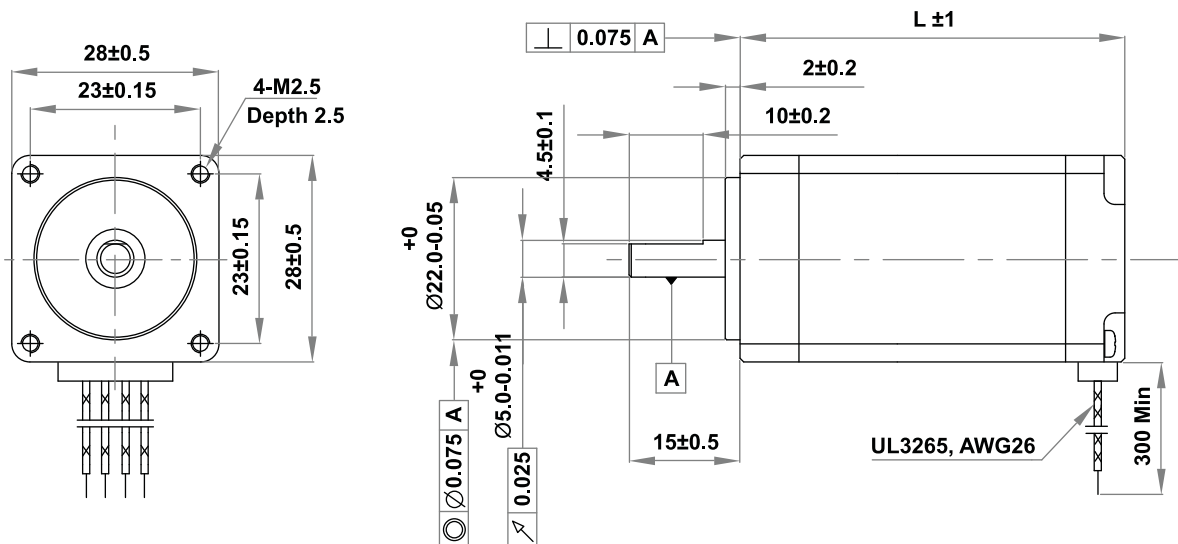

## 4.4 BM-35 Series

### 4.4.1 Motor Specifications

M O D E L		UNIT	BM-35S	BM-35M	BM-35L	BM-35XL
DRIVE METHOD		----	BI-POLAR	BI-POLAR	BI-POLAR	BI-POLAR
NUMBER OF PHASES		----	2	2	2	2
VOLTAGE		VDC	2.28	2.88	4.59	5.39
CURRENT per PHASE		A	0.6	0.6	0.85	0.7
RESISTANCE per PHASE		Ohm	3.8	4.8	5.4	7.7
INDUCTANCE per PHASE		mH	3.2	6.1	6.5	8.4
HOLDING TORQUE		N · m	0.034	0.050	0.176	0.225
ROTOR INERTIA		g · cm <sup>2</sup>	5	8	11	32
WEIGHTS		g	105	120	200	300
LENGTH (L)		mm	22	26	38	535
ALLOWABLE OVERHUNG LOAD (DISTANCE FROM END OF SHAFT)	3mm	N	22	22	22	22
	8mm		26	26	26	26
	13mm		33	33	33	33
	18mm		46	46	46	46
ALLOWABLE THRUST LOAD		N	Lower than motor weight			
INSULATION RESISTANCE		MOhm	100min. (at 500VDC)			
INSULATION CLASS		----	CLASS B (130°C)			
OPERATING TEMPERATURE		°C	0 to 55			

### 4.4.2 Motor Dimension (mm) and Torque Characteristics

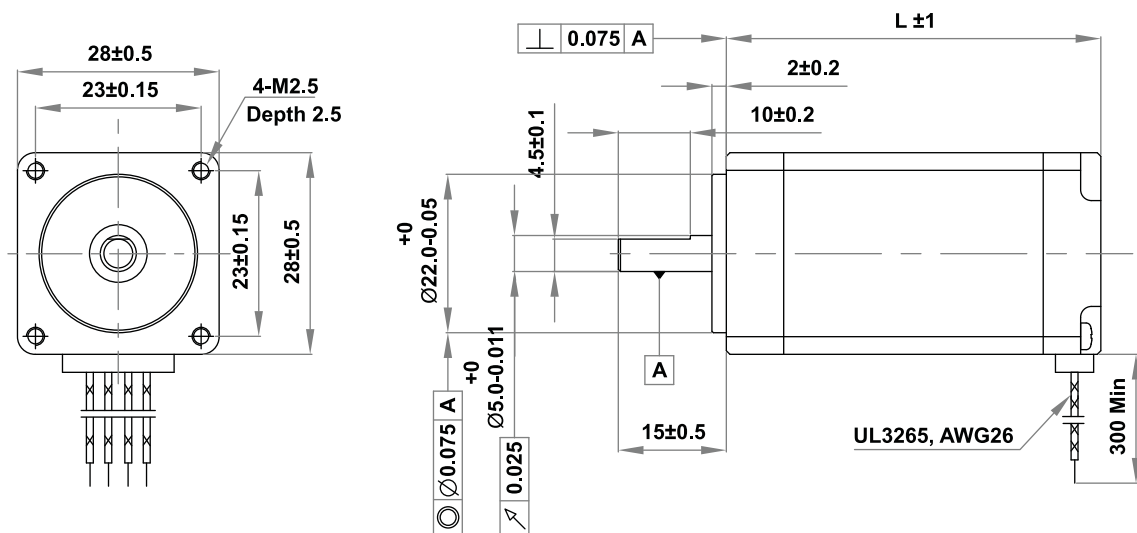

## 4.5 BM-42 Series

### 4.5.1 Motor Specifications

M O D E L		UNIT	BM-42S	BM-42M	BM-42L	BM-42XL
DRIVE METHOD		----	BI-POLAR	BI-POLAR	BI-POLAR	BI-POLAR
NUMBER OF PHASES		----	2	2	2	2
VOLTAGE		VDC	3.36	4.32	4.56	7.2
CURRENT per PHASE		A	1.2	1.2	1.2	1.2
RESISTANCE per PHASE		Ohm	2.8	3.6	3.8	6.0
INDUCTANCE per PHASE		mH	2.5	7.2	8.0	15.6
HOLDING TORQUE		N · m	0.32	0.44	0.5	0.65
ROTOR INERTIA		g · cm <sup>2</sup>	35	54	77	114
WEIGHTS		g	220	280	350	500
LENGTH (L)		mm	33	39	47	59
ALLOWABLE OVERHUNG LOAD (DISTANCE FROM END OF SHAFT)	3mm	N	22	22	22	22
	8mm		26	26	26	26
	13mm		33	33	33	33
	18mm		46	46	46	46
ALLOWABLE THRUST LOAD		N	Lower than motor weight			
INSULATION RESISTANCE		MOhm	100min. (at 500VDC)			
INSULATION CLASS		----	CLASS B (130°C)			
OPERATING TEMPERATURE		°C	0 to 55			

### 4.5.2 Motor Dimension(mm) and Torque Characteristics

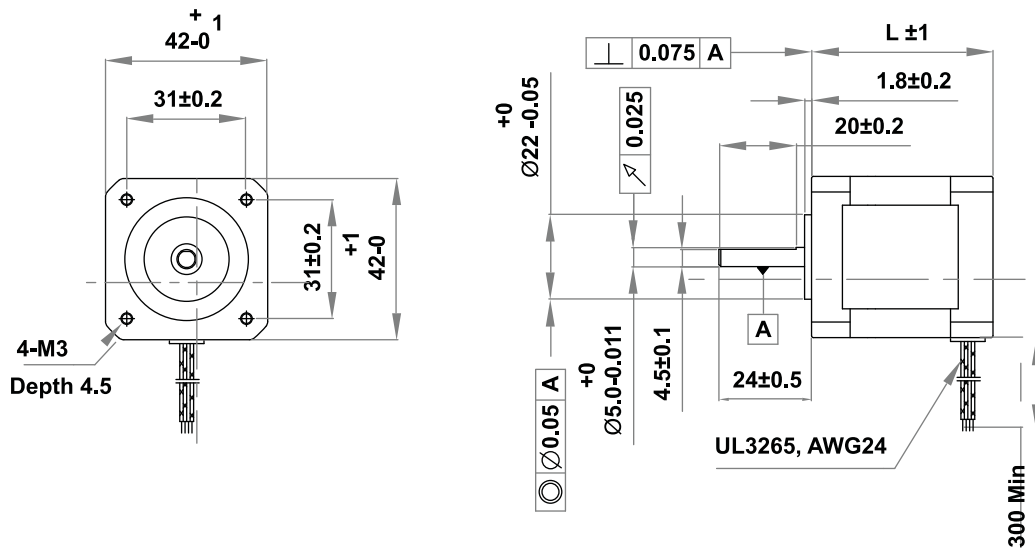

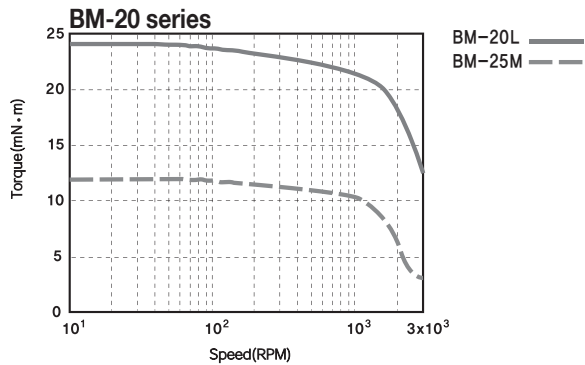

※Measured Condition  
 Motor Voltage = 24VDC  
 Motor Current = Rated Current(Refer to Motor Specification)  
 Drive = Ezi-STEP MINI

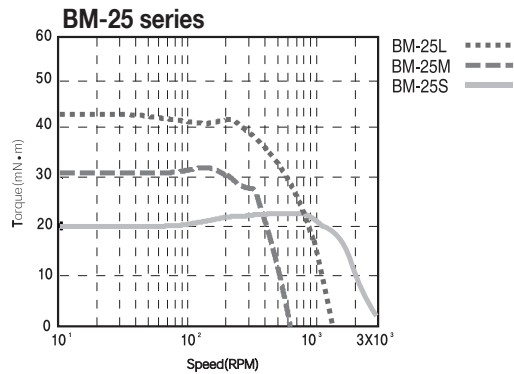

※Measured Condition  
 Motor Voltage = 24VDC  
 Motor Current = Rated Current(Refer to Motor Specification)  
 Drive = Ezi-STEP MINI

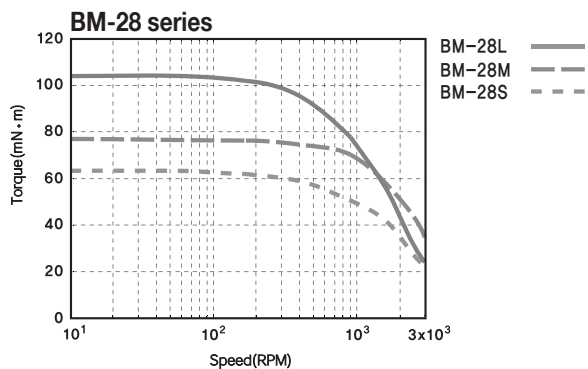

※Measured Condition  
 Motor Voltage = 24VDC  
 Motor Current = Rated Current(Refer to Motor Specification)  
 Drive = Ezi-STEP MINI

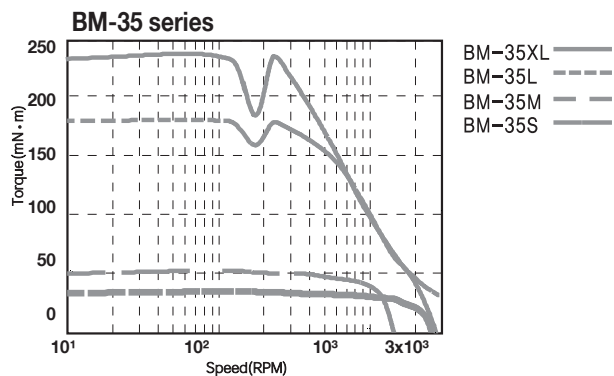

※Measured Condition  
 Motor Voltage = 24VDC  
 Motor Current = Rated Current(Refer to Motor Specification)  
 Drive = Ezi-STEP MINI

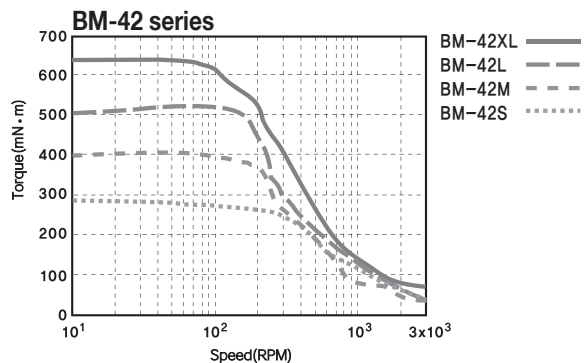

※Measured Condition  
 Motor Voltage = 24VDC  
 Motor Current = Rated Current(Refer to Motor Specification)  
 Drive = Ezi-STEP MINI

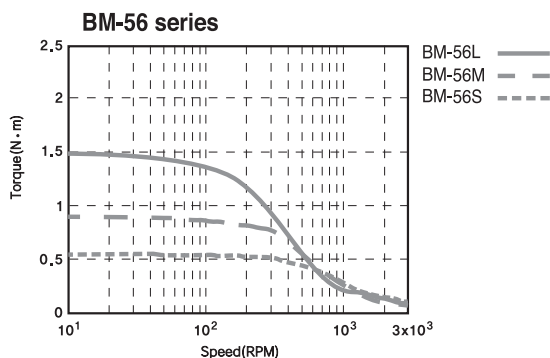

※Measured Condition  
 Motor Voltage = 24VDC  
 Motor Current = Rated Current(Refer to Motor Specification)  
 Drive = Ezi-STEP MINI



## 5. Installation and Cabling

### 5.1 Notes on Installation

- 1) Ezi-STEP MINI is designed for indoor use only.
- 2) The ambient temperature of the room should be 0°C~50°C.
- 3) If the temperature of the product case is higher than 50°C, radiate heat of the outside to cool down.
- 4) Do not install Ezi-STEP MINI under direct rays, near magnetic or radioactive objects.
- 5) If you set more than 2 drives, you must set over 20mm horizontally and over 50mm vertically as shown below.

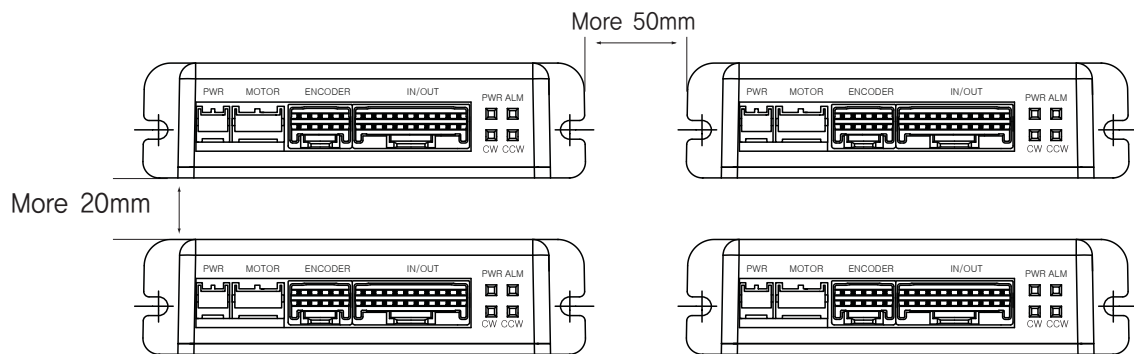

## 5.2 Connection Diagram

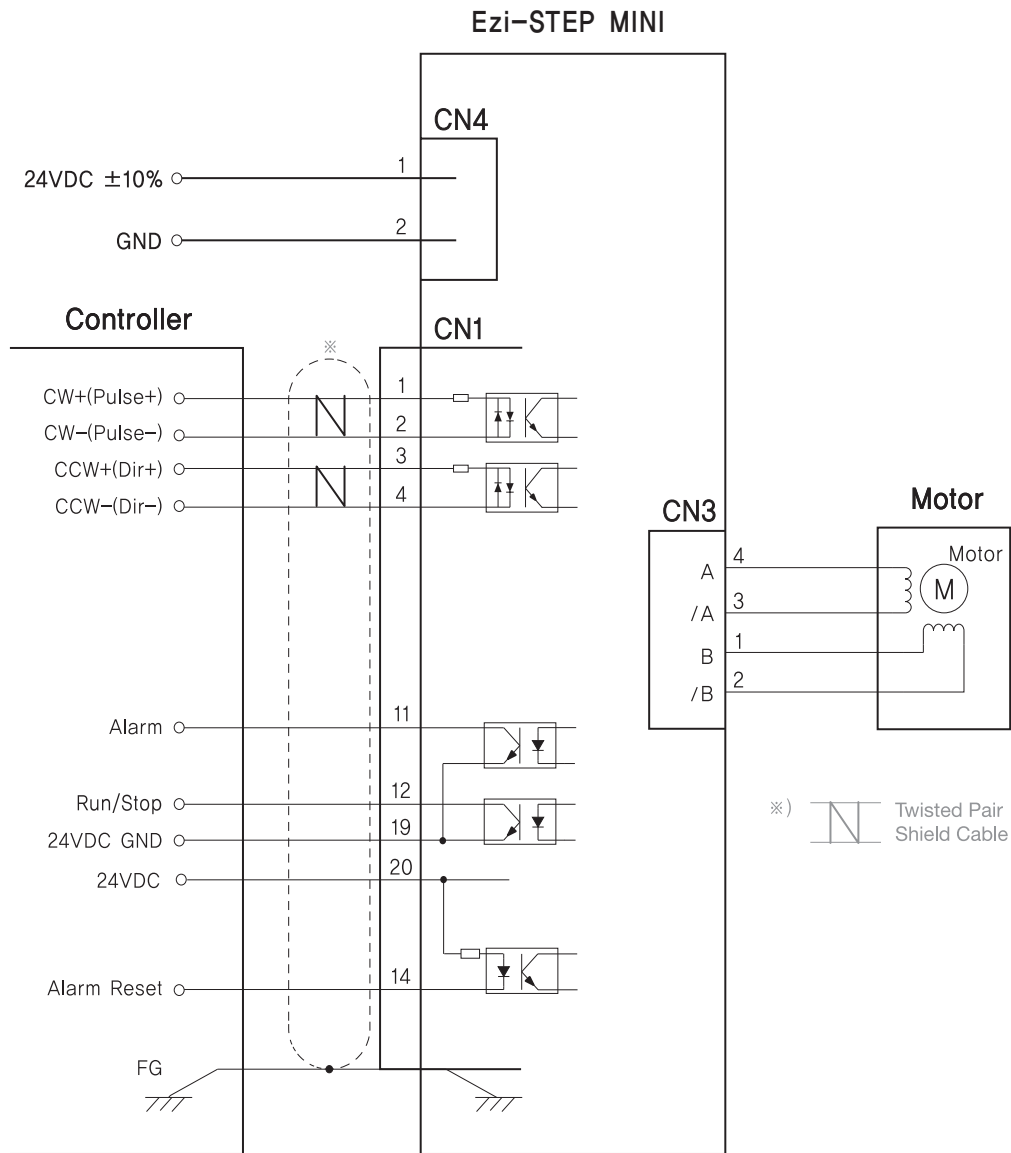

## 6. Setting and Operation

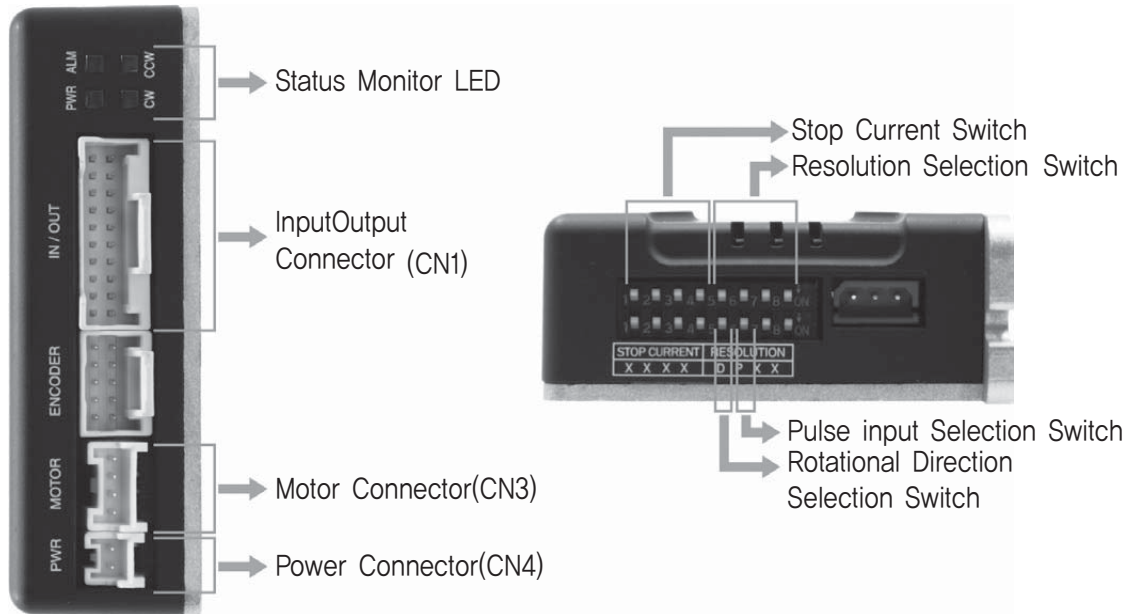

### 6.1 Status Monitor LED

#### 6.1.1 Status LED Function and Condition

Indication	Color	Function	Flash Condition
PWR	Green	Power Input Indication	Lights when power is ON Flashes when motor is Free status
ALM	Red	Alarm Indication	Flash when protection function is activated (Identifiable which protection mode is activated by counting the flash times)
CW	Yellow	Motor Rotation Direction	Lights when motor rotate CW direction
CCW	Orange	Motor Rotation Direction	Lights when motor rotate CCW direction

## 6.1.2 Protection functions and LED flash times

Times	Protection	Conditions
1	Over Current Error	Excessive current flowed into a motor
2	Over Speed Error	Motor speed exceeded 3000 rpm
3	Step Out Error	Abnormally motor do not followed pulsed input
5	Over Temperature Error	Internal temperature of a motor drive exceeded 55°C
6	Over Regenerative Voltage Error	Back EMF more than 50V
7	Motor Connect Error	Power is ON without connection of motor cable to drive
9	Motor Voltage Error	Motor voltage is below 20V
11	System Error	Error occurs in drive system
12	ROM Error	Error occurs in Parameter storage Device(ROM)
14	Input Voltage Error	Power source voltage is out of limited value [20V~28V]

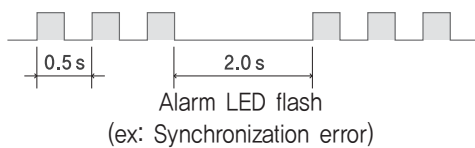

## 6.2 Pulse Input Selection Switch

Indication	Switch Name	Functions
2P/1P	Selecting Pulse Input Mode	Selectable 1-Pulse input mode or 2-Pulse input mode as Pulse input signal, ON : 1-Pulse mode OFF : 2-Pulse mode ※Default : 2-Pulse mode

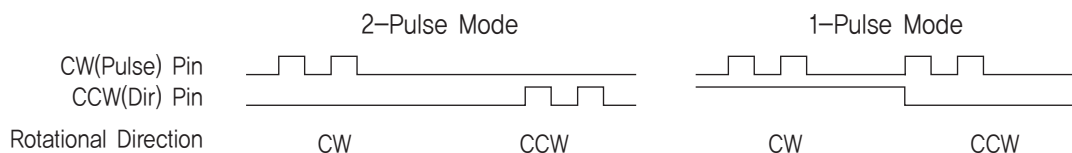

### 6.3 Rotational Direction Selection Switch

Indication	Switch Name	Functions
DIR	Switching Rotational Direction	Based on CW(+Dir signal) input to driver. ON : CCW(-Direction) OFF : CW(+Direction) ※Default : CW mode

Direction selection switch :  
**ON**  
CCW Dir.



Direction selection switch :  
**OFF**  
CW Dir.

### 6.4 Resolution Selection Switch

The number of pulse per revolution.

Position				Pulse/Rotation	Position				Pulse/Rotation
8	7	6	5		8	7	6	5	
ON	ON	ON	ON	500	OFF	ON	ON	ON	6400
ON	ON	ON	OFF	1000	OFF	ON	ON	OFF	8000
ON	ON	OFF	ON	1600	OFF	ON	OFF	ON	10000*1
ON	ON	OFF	OFF	2000	OFF	ON	OFF	OFF	20000
ON	OFF	ON	ON	3200	OFF	OFF	ON	ON	25000
ON	OFF	ON	OFF	3600	OFF	OFF	ON	OFF	36000
ON	OFF	OFF	ON	4000	OFF	OFF	OFF	ON	40000
ON	OFF	OFF	OFF	5000	OFF	OFF	OFF	OFF	50000

\*1 : Default = 10,000

## 6.5 Stop Current Selection

Stop Current means the motor current value automatically set in 0.1 sec after motor stops. This is to prevent the overheat of a motor when the motor is under long time idling. The unit of the selection value is a percentage.

Indication				STOP Current(%)	Indication				STOP Current(%)
4	3	2	1		4	3	2	1	
ON	ON	ON	ON	10	OFF	ON	ON	ON	90
ON	ON	ON	OFF	20	OFF	ON	ON	OFF	100
ON	ON	OFF	ON	30	OFF	ON	OFF	ON	10
ON	ON	OFF	OFF	40	OFF	ON	OFF	OFF	10
ON	OFF	ON	ON	50*1	OFF	OFF	ON	ON	10
ON	OFF	ON	OFF	60	OFF	OFF	ON	OFF	10
ON	OFF	OFF	ON	70	OFF	OFF	OFF	ON	10
ON	OFF	OFF	OFF	80	OFF	OFF	OFF	OFF	10

\*1 : Default : '50%'

## 6.6 Input/Output Signal(CN1)

Pin No.	Function	I/O Signal	Pin Layout
1	CW+(Pulse+)	Input	<p>The diagram shows a 20-pin connector layout. Pin 1 is at the bottom left, pin 2 is at the bottom right, pin 19 is at the top left, and pin 20 is at the top right. The pins are arranged in two columns of 10 pins each.</p>
2	CW-(Pulse-)	Input	
3	CCW+(Dir+)	Input	
4	CCW-(Dir-)	Input	
11	Alarm	Output	
12	Run/stop	Output	
14	Alarm Reset	Input	
19	24VDC GND	Input	
20	24VDC	Input	

### 6.7 Motor Connector(CN3)

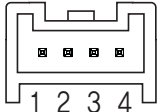
Pin No.	Function	Pin Layout
1	B Phase	
2	/B Phase	
3	/A Phase	
4	A Phase	

### 6.8 Power Connector(CN4)

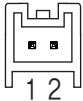
Pin No.	Function	Pin Layout
1	Input Power : 24VDC $\pm$ 10%	
2	Input Power : GND	

## 7. System Configuration

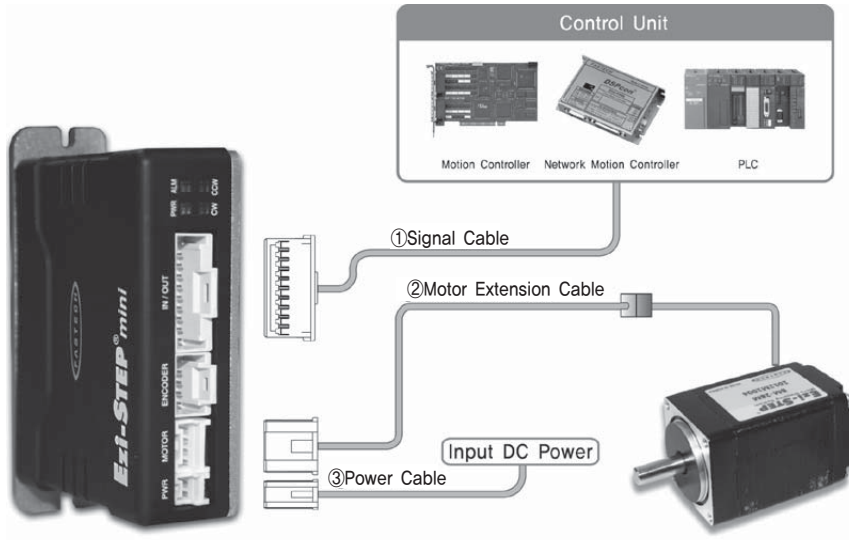

Type	Signal Cable	Motor Cable	Power Cable
Standard Length	–	30cm	–
Max. Length	20m	20m	2m

※Motor can not be directly connected to Drives so please use extension cable for connection, (Option)

### 7.1 Option

#### ①Signal Cable

Available to connect between Control Unit and Ezi-STEP MINI.

Item	Length[m]	Remark
CSVI-S-□□□F	□□□	Normal Cable
CSVI-S-□□□M	□□□	Robot Cable

□ is for Cable Length. The unit is 1m and Max, 20m length.

#### ②Motor Extension Cable

Available to extended connection between motor and Ezi-STEP MINI.

Item	Length[m]	Remark
CMNB-M-□□□F	□□□	Normal Cable
CMNB-M-□□□M	□□□	Robot Cable

□ is for Cable Length. The unit is 1m and Max, 20m length.

#### ③Power Cable

Available to connect between Power and Ezi-STEP MINI.

Item	Length[m]	Remark
CMNB-P-□□□F	□□□	Normal Cable
CMNB-P-□□□M	□□□	Robot Cable

□ is for Cable Length. The unit is 1m and Max, 2m length.



## 8. Control signal Input/Output Description

### 8.1 Input Signal

Input signal of the drive are all photocoupler inputs. The signal shows the status of internal photocouplers [ON: conduction], [OFF: Non-conduction], not displaying the voltage levels of the signal.

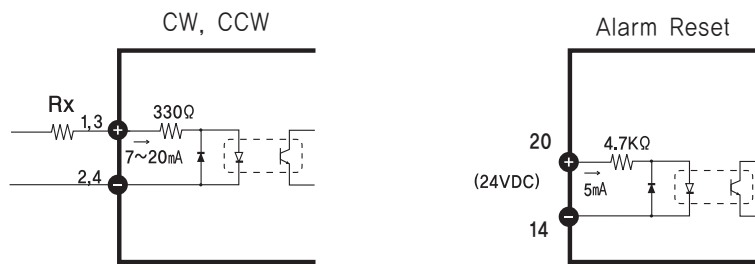

#### ◆ CW, CCW Input

This signal can be used to receive a positioning pulse command from a user-side host motion controller. A user can select 1-pulse input mode or 2-pulse input mode. The input schematic of CW, CCW is designed for 5V TTL level. When using 5V level as an input signal, the resistor Rx is used and connect to the drive directly. When the level of input signal is more than 5V, have to add Rx. If this resistor is absent, the inner schematic can be broken. In input signal level is 12V case, Rx value is 680ohm and in 24V case, 1.8kohm is suitable for Rx value.

#### ◆ Alarm Reset Input

When a protection mode has been activated, a signal to this Alarm Reset input cancels the Alarm output. By setting the alarm reset input signal [ON], cancel Alarm output. Before cancel the Alarm output, have to remove the source of alarm.

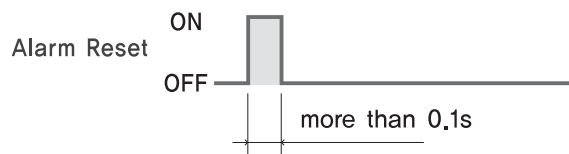

**[Caution]** If Alarm Reset input signal still remains [ON], motor will be Free state. Keep in mind to change [ON]→[OFF] state. It operates reversely compare to Normal mode, when you set Inverse mode.

## 8.2 Output Signal

As the output signal from the drive, there are the photocoupler outputs(Alarm, Run/ Stop). The signal status operate as [ON : conduction], [OFF : Non-conduction] of photocoupler not as the voltage level of signal.

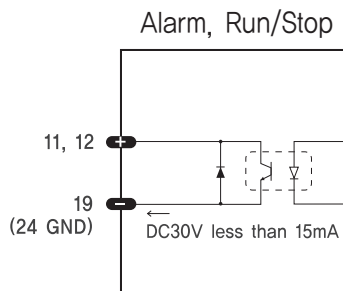

### ◆ Alarm Output

The Alarm output indicates [OFF] when the drive is in a normal operation. If a protection mode has been activated, it goes [ON]. A host controller needs to detect this signal and stop sending a motor driving command. When the drive detects an abnormal operation such as overload or overcurrent of a motor, it sets the Alarm output to [ON], flash the Alarm LED, disconnects the power to a motor, and stops the motor, simultaneously. It operates reversely compare to Normal mode, when you set Inverse mode.

### ◆ Run/Stop Output

Run/Stop Output state is [ON] when motor positioning is completed. It operates reversely compare to Normal mode, when you set inverse mode.

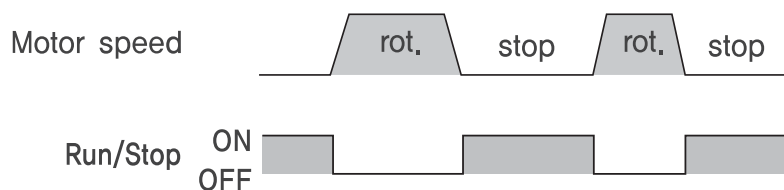

# Appendix

## ▪ Extension cable for Motor

For cable extension between Motor and Drive.

### WIRING DIAGRAM

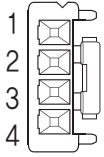
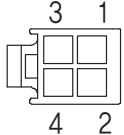
Drive Connector		Cabling	Motor Connector	
Pin Layout	Number		Number	Pin Layout
	1 2 3 4	----- ----- ----- -----	1 3 4 2	

### CONNECTOR

ITEM		Part Number	Maker
Drive Connector (CN3)	Housing	PAP-04V-S	JST
	Terminal	SPHD-001T-P0,5	JST
Motor Connector	Housing	5557-04R	MOLEX
	Terminal	5556T	MOLEX

## ■ Connector

Connector specifications for cabling to Ezi-STEP MINI.

ITEM		Part Number	Maker
Signal (CN1)	Housing	501646-2000	MOLEX
	Terminal	501648-1000(AWG 26~28)	MOLEX
	Connector	10120-3000VE	3M
	Backshell	10320-52AO-008	3M
Motor (CN3)	Housing	PAP-04V-S	JST
	Terminal	SPHD-001T-P0,5	JST
Motor Side	Housing	5557-04R	MOLEX
	Terminal	5556T	MOLEX
Power (CN4)	Housing	PAP-02V-S	JST
	Terminal	SPHD-001T-P0,5	JST
	Housing	5557-02R	MOLEX
	Terminal	5556T	MOLEX

※These connectors are serviced together with Ezi-STEP MINI except when purchasing option cables.

※Above connector is the most suitable product for Ezi-STEP MINI. Another equivalent connector can be used.

▪ **MEMO**



*Fast, Accurate, Smooth Motion*

**FASTECH Co., Ltd.**

Rm #1202, Bucheon Technopark 401 Dong, Yakdea-dong,  
Wonmi-Gu, Bucheon-si, Gyeonggi-do, Rep. Of Korea (Zip)420-734  
TEL : 82-32-234-6300,6301 FAX : 82-32-234-6302  
E-mail : fastech@fastech.co.kr Homepage : www.fastech.co.kr

- Please note that the specifications are subject to change without notice due to product improvements.

© Copyright 2007 FASTECH Co., Ltd. Jan 06, 2014 Rev.1