

# **Ezi-STEP<sup>®</sup>**

**Step Motors with Integrated Drive**

# **BT**



**CE**



*Fast, Accurate, Smooth Motion*

[www.fastech.co.kr](http://www.fastech.co.kr)

## Table of Contents

<b>1. Precautions</b>	1
<b>2. Main Characteristics</b>	5
<b>3. Drive Specification and Dimension</b>	7
3.1 Drive Specification	7
<b>4. Motor Specification and Size</b>	8
4.1 BT-42 Series	8
4.2 BT-56 Series	9
4.3 BT-86 Series	10
4.4 Motor Torque Characteristics	11
<b>5. Installation and Cabling</b>	12
5.1 Notes on Installation	12
5.2 Connection Diagram	12
<b>6. Setting and Operating</b>	14
6.1 Status monitor LED	14
6.2 Power Connection Connector(CN1)	15
6.3 Signal Connection Connector(CN2)	16
6.4 Communication Connection Connector(CN3)	16
<b>7. Setting Up Parameters</b>	17
7.1 Setting Up Parameters	17
7.2 Resolution Selection	17
7.3 Stop Current Selection	18
7.4 Rotational Direction Selection	18
7.5 Pulse Input Selection	18
7.6 Alarm Reset Input Selection	18
7.7 Alarm Output Selection	19
7.8 RUN/STOP Output Selection	19
7.9 Motor Number, Motor Coils Current	19
<b>8. System Configuration</b>	20
8.1 Option	20
<b>9. Control Signal Input/Output Description</b>	21
9.1 Input signal	21
9.2 Output signal	22
<b>Appendix</b>	23
Cable for RS-232C	23
Connector	23

## ※ Before operation ※

- Thank you for your purchasing Ezi-STEP BT.
- Ezi-STEP BT is an all-in-one Unit. For high-speed and high-precision drive of a stepping motor, Ezi-STEP BT is a unique drive that adopts a new control scheme owing to an on-board high-performance 32bit digital signal processor.
- This manual describes handling, maintenance, repair, diagnosis and troubleshooting of Ezi-STEP BT.
- Before operating Ezi-STEP BT, thoroughly read this manual.
- After reading the manual, keep the manual near the Ezi-STEP BT so that any user can read the manual whenever needed.

## 1. Precautions

### ◆ General Precautions

- Contents of this manual are subject to change without prior notice for functional improvement, change of specifications or user's better understanding.  
Thoroughly read the manual provided with the purchased Ezi-STEP BT.
- When the manual is damaged or lost, please contact with Fastech's agents or our company at the address on the last page of the manual.
- Our company is not responsible for a product breakdown due to user's dismantling for the product, and such a breakdown is not guaranteed by the warranty.

### ◆ Put the Safety First

- Before installation, operation and repairing the Ezi-STEP BT, thoroughly read the manual and fully understand the contents. Before operating the Ezi-STEP BT please, understand the mechanical characteristics of the Ezi-STEP BT and related safety information and precautions.
- This manual divides safety precautions into **Attention** and **Warning**.



#### **Attention :**

If user does not properly handle the product, the user may seriously or slightly injured and damages may occur in the machine.



#### **Warning :**



If user does not properly handle the product, a dangerous situation (such as an electric shock) may occur resulting in deaths or serious injuries.

- Although precaution is only a **Attention**, a serious result could be caused depending on the situation. Follow safety precautions.



## ◆ Check the Product

 <b>Attention</b>	<p>Check the Product is damaged or parts are missing. Otherwise, the machine may get damaged or the user may get injured.</p>
--	---

## ◆ Installation

 <b>Attention</b>	<p>Carefully move the Ezi-STEP BT. Otherwise the Product may get damaged or User's foot may get injured by dropping the product.</p> <p>Use non-flammable materials such as metal in the place where the Ezi-STEP BT is to be installed. Otherwise, a fire may occur.</p> <p>When installing several Ezi-STEP BT in a sealed place, install a cooling fan to keep the ambient temperature of the Ezi-STEP BT as 50°C or lower. Otherwise, a fire or other kinds of accidents may occur due to overheating.</p>
 <b>Warning</b>	<p>The process of Installation, Connection, Operation, Checking and Repairing should be done with qualified person. Otherwise, a fire or other kinds of accidents may occur.</p>

## ◆ Connect Cables

 <b>Attention</b>	<p>Keep the rated range of Input Voltage for Ezi-STEP BT. Otherwise, a fire or other kinds of accidents may occur.</p> <p>Cable connection should follow the wiring diagram. Otherwise, a fire or other kinds of accidents may occur.</p>
 <b>Warning</b>	<p>Before connecting cables, check if input power is off. Otherwise, an electric shock or a fire may occur.</p> <p>The case of the Ezi-STEP BT is insulated from the ground of the internal circuit by the condenser. Ground the Ezi-STEP BT. Otherwise, an electric shock or a fire may occur.</p>

## ◆ Operation



### Attention

If a protection function(alarm) occurs, firstly remove its cause and then release(alarm reset) the protection function.

If you are operating continuously without removing its cause, the machine may get damaged or the user may get injured.

**Do not make Motor Free and make input signal to ON during operation.**

Motor will stop and stop current will become zero. The machine may get damaged or the user may get injured.

**Make all input signals to OFF before supply input voltage to Ezi-STEP BT.**

The machine may get damaged or the user may get injured by motor operation.

**All parameter values are set by default factory setting value. Change this value after reading this manual thoroughly.**

Otherwise, the machine may get damaged or other kinds of accidents may occur.

## ◆ Check and Repair



### Warning

**Stop supplying power to the main circuit and wait for a while before checking or repairing the Ezi-STEP BT.**

Electricity remaining in the capacitor may cause danger.

**Do not change cabling while power is being supplied.**

Otherwise, the user may get injured or the product may get damaged.

**Do not reconstruct the Ezi-STEP BT.**

Otherwise, an electric shock may occur or the reconstructed product can not get After-Service.

## ■ Part Numbering

### Ezi-STEP-BT-42S-□

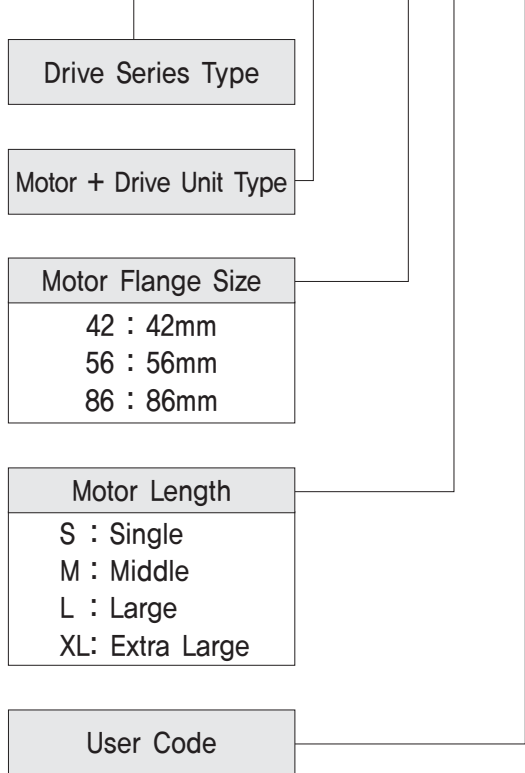

## ■ Combination List of Ezi-STEP BT

Unit Part Number
Ezi-STEP-BT-42S
Ezi-STEP-BT-42M
Ezi-STEP-BT-42L
Ezi-STEP-BT-42XL
Ezi-STEP-BT-56S
Ezi-STEP-BT-56M
Ezi-STEP-BT-56L
Ezi-STEP-BT-86M
Ezi-STEP-BT-86L
Ezi-STEP-BT-86XL

## 2. Main characteristics

### 1 Sensorless Stall Detection

#### Detecting the loss-of-synchronization with on-board DSP (Patent pending)

Ezi-STEP<sup>®</sup> can detect the loss-of-synchronization of a stepping motor without the addition of an external sensor. By monitoring the voltage, current, and back-emf signal, the on-board DSP estimates the current position of a rotor and enables it to detect the loss-of-synchronization (an impossible task for a conventional stepping motor drive), this allows for high-speed operation at 100% torque rating without loss-of-synchronization\*.

\*Effective only over 300rpm

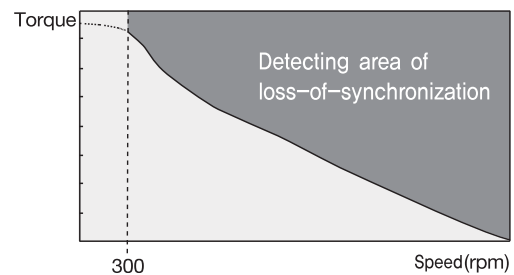

### 2 Microstep and Filtering

#### High precision Microstep function and Filtering (Patent pending)

The high-performance DSP operates at step resolutions of  $1.8^\circ$  up to maximum  $0.0072^\circ$  (1/250 steps) and Ezi-STEP<sup>®</sup> adjusts PWM control signal in every  $25\mu$  sec, which makes it possible for more precise current control, resulting in high-precision Microstep operation.

### 3 Software Damping

#### Vibration suppression and high-speed operation (Patent pending)

Vibration suppression and High-speed operation (Patent pending) Motor vibration is created by magnetic flux variations of the motor, lower current from the drive due to back-emf from the motor at high speeds and lowering of phase voltages from the drive. Ezi-STEP<sup>®</sup> drive detects these problems and the DSP adjusts the phase of the current according to the pole position of the motor, drastically suppressing vibration. This allows the smooth operation of the motor at high speed.

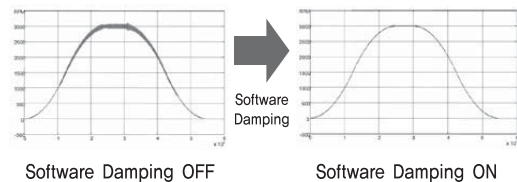

\*This is real measured speed that using 100000[pulse/rev] encoder.

## **4 Drive Output Signal Monitoring**

Ezi-STEP<sup>®</sup> provides loss of step, run/stop, over-current, over-heat, over-voltage, power, and motor connection alarms that can be monitored by the controller and visible by a motor-mounted flashing led indicator.

## **5 Improvement of High-Speed Driving**

Depending on the speed of a stepping motor, Ezi-STEP<sup>®</sup> automatically increases the supply voltage and prevents the torque lowering due to the low operating voltage to the motor caused by back-emf voltage, this enables high-speed operation. Additionally, the software damping algorithm minimizes the vibration and prevents the loss-of-synchronization at high-speed.



### 3. Drive Specification and Dimension

#### 3.1 Drive Specification

Motor Model	BT-42 Series	BT-56 Series	BT-86 Series	
Input Voltage	24VDC $\pm$ 10%	24VDC $\pm$ 10%	40~70VDC	
Control Method	Bipolar PWM drive with 32bit DSP			
Current Consumption	Max : 500mA (Except motor current)			
Operating Condition	Ambient Temperature	In Use : 0~50°C In Storage : -20~70°C		
	Humidity	In Use : 35~85%RH (Non-Condensing) In Storage : 10~90%RH (Non-Condensing)		
	Vib. Resist.	0.5G		
Function	Resolution (P/R)	500 1,000 1,600 2,000 3,200 3,600 4,000 5,000 6,400 8,000 10,000 20,000 25,000 36,000 40,000 50,000 (Set by RS-232C Communication) *Default : 10,000		
	Max. Input Pulse Frequency	500KHz (Duty 50%)		
	Protection Functions	Over Current Error, Over Speed Error, Step Out Error, Over Temperature Error, Over Regenerated Voltage Error, Motor Connect Error, Motor Voltage Error, System Error, ROM Error, Input voltage Error (Identifiable which alarm is activated by counting the blinking times of status monitor LED)		
	LED Display	Power Status(Green), Alarm Status(Red)		
	STOP Current	10%~100% (Set by RS-232C Communication) Be settled to set value of STOP Current after 0.1 second after motor stop. *Default : 50%		
	Pulse Input Method	1 Pulse/2 Pulse (Set by RS-232C Communication) 1 Pulse : Pulse/Direction, 2 Pulse : CW/CCW *Default : 2 Pulse		
	Rotational Direction	CW/CCW (Set by RS-232C Communication) Used when changing the direction of motor rotate. *Default : CW		
	Speed/Position Control Command	Pulse train input (Photocoupler Input)		
	I/O Signal	Input Signal	Motor Free/Alarm Reset (Photocoupler Input)	
Output Signal		Alarm, Run/Stop (Photocoupler Output)		

## 4. Motor specifications and Size

### 4.1 BT-42 Series

#### 4.1.1 Motor Specifications

M O D E L		UNIT	BT-42S	BT-42M	BT-42L	BT-42XL
DRIVE METHOD		----	BI-POLAR	BI-POLAR	BI-POLAR	BI-POLAR
NUMBER OF PHASES		----	2	2	2	2
VOLTAGE		VDC	3.36	4.32	4.56	7.2
CURRENT per PHASE		A	1.2	1.2	1.2	1.2
RESISTANCE per PHASE		Ohm	2.8	3.6	3.8	6.0
INDUCTANCE per PHASE		mH	2.5	7.2	8.0	15.6
HOLDING TORQUE		N · m	0.32	0.44	0.5	0.65
ROTOR INERTIA		g · cm <sup>2</sup>	35	54	77	114
WEIGHTS		g	220	280	350	500
LENGTH (L)		mm	33	39	47	59
ALLOWABLE OVERHUNG LOAD (DISTANCE FROM END OF SHAFT)	3mm	N	22	22	22	22
	8mm		26	26	26	26
	13mm		33	33	33	33
	18mm		46	46	46	46
ALLOWABLE THRUST LOAD		N	Lower than motor weight			
INSULATION RESISTANCE		MOhm	100min. (at 500VDC)			
INSULATION CLASS		----	CLASS B (130°C)			
OPERATING TEMPERATURE		°C	0 to 55			

#### 4.1.2 Motor Dimension (mm)

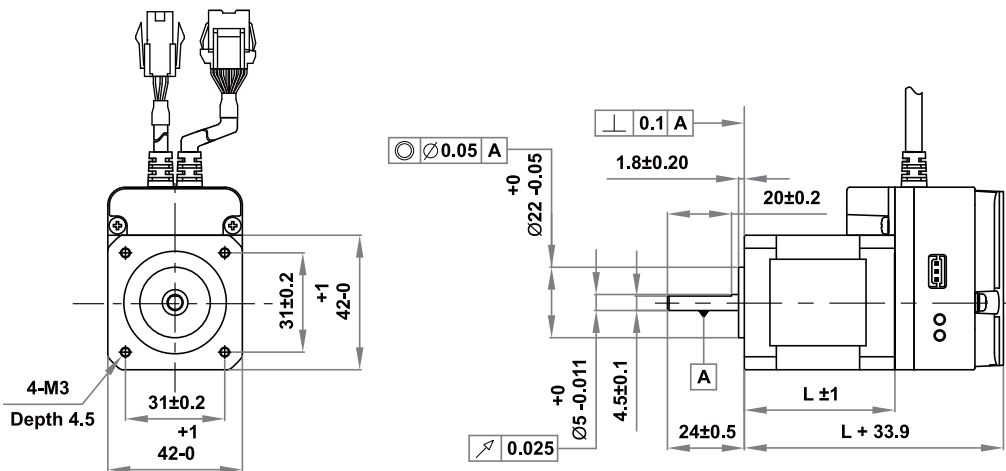

## 4.2 BT-56 Series

### 4.2.1 Motor Specifications

M O D E L		UNIT	BT-56S	BT-56M	BT-56L
DRIVE METHOD		----	BI-POLAR	BI-POLAR	BI-POLAR
NUMBER OF PHASES		----	2	2	2
VOLTAGE		VDC	1.56	1.62	2.7
CURRENT per PHASE		A	3	3	3
RESISTANCE per PHASE		Ohm	0.52	0.54	0.9
INDUCTANCE per PHASE		mH	1.0	2.0	3.8
HOLDING TORQUE		N · m	0.64	1.0	1.5
ROTOR INERTIA		g · cm <sup>2</sup>	120	200	480
WEIGHTS		g	500	700	1150
LENGTH (L)		mm	46	54	80
ALLOWABLE OVERHUNG LOAD (DISTANCE FROM END OF SHAFT)	3mm	N	52	52	52
	8mm		65	65	65
	13mm		85	85	85
	18mm		123	123	123
ALLOWABLE THRUST LOAD		N	Lower than motor weight		
INSULATION RESISTANCE		MOhm	100min. (at 500VDC)		
INSULATION CLASS		----	CLASS B (130°C)		
OPERATING TEMPERATURE		°C	0 to 55		

### 4.2.2 Motor Dimension (mm)

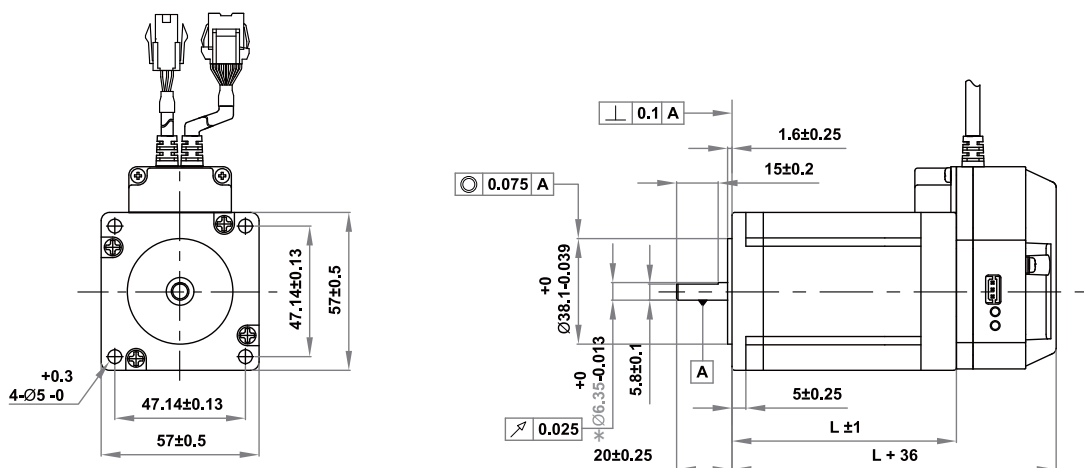

\* : There are 2 kinds size of front shaft diameter for BT-56 series as ∅6.35 and ∅8.0.

## 4.3 BT-86 Series

### 4.3.1 Motor Specifications

M O D E L		UNIT	BT-86M	BT-86L	BT-86XL
DRIVE METHOD		----	BI-POLAR	BI-POLAR	BI-POLAR
NUMBER OF PHASES		----	2	2	2
VOLTAGE		VDC	2.4	3.6	4.38
CURRENT per PHASE		A	6	6	6
RESISTANCE per PHASE		Ohm	0.4	0.6	0.73
INDUCTANCE per PHASE		mH	3.5	6.5	8.68
HOLDING TORQUE		N · m	4.0	7.5	9.0
ROTOR INERTIA		g · cm <sup>2</sup>	1400	2700	4000
WEIGHTS		Kg	2.3	3.8	5.3
LENGTH (L)		mm	79	117	155
ALLOWABLE OVERHUNG LOAD (DISTANCE FROM END OF SHAFT)	3mm	N	270	270	270
	8mm		300	300	300
	13mm		350	350	350
	18mm		400	400	400
ALLOWABLE THRUST LOAD		N	Lower than motor weight		
INSULATION RESISTANCE		MOhm	100min. (at 500VDC)		
INSULATION CLASS		----	CLASS B (130°C)		
OPERATING TEMPERATURE		°C	0 to 55		

### 4.3.2 Motor Dimension (mm)

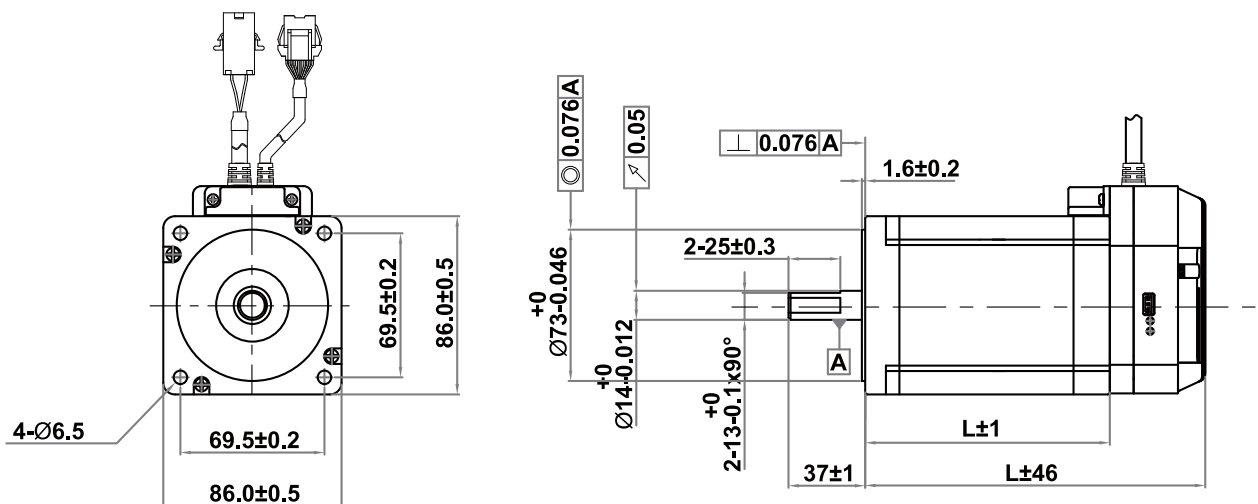

## 4.4 Motor Torque Characteristics

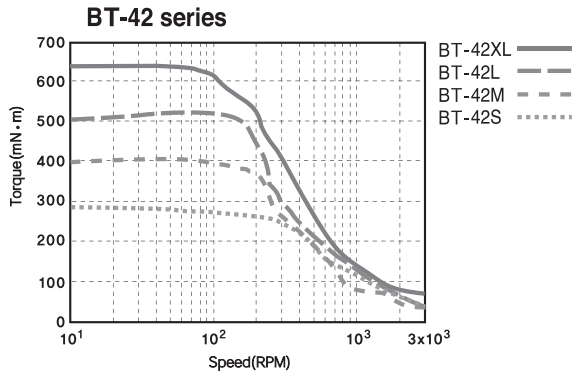

※ Measured Condition

Motor Voltage = 24VDC

Motor Current = Rated Current(Refer to Motor Specification)

Drive = Ezi-STEP BT

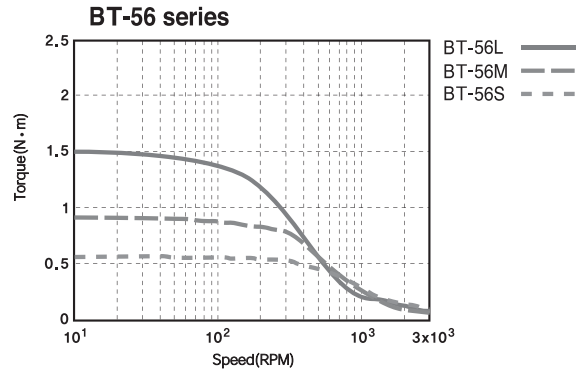

※ Measured Condition

Motor Voltage = 24VDC

Motor Current = Rated Current(Refer to Motor Specification)

Drive = Ezi-STEP BT

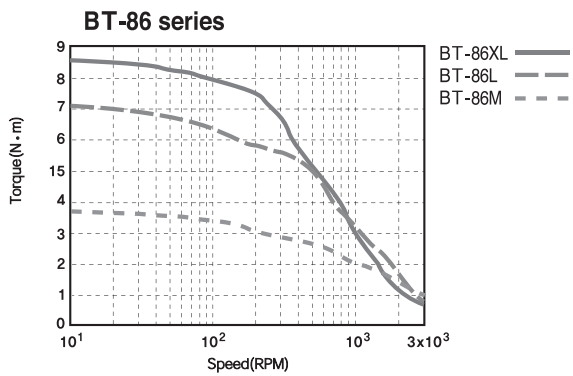

※ Measured Condition

Motor Voltage = 70VDC

Motor Current = Rated Current(Refer to Motor Specification)

Drive = Ezi-STEP BT

## 5. Installation and Cabling

### 5.1 Notes on Installation

- 1) Ezi-STEP BT is designed for indoor use only.
- 2) The ambient temperature of the room should be 0°C~50°C.
- 3) If the temperature of the product case is higher than 50°C, radiate heat of the outside to cool down.
- 4) Do not install Ezi-STEP BT under direct rays, near magnetic or radioactive objects.

### 5.2 Connection Diagram

#### Ezi-STEP-BT-42/56 Series

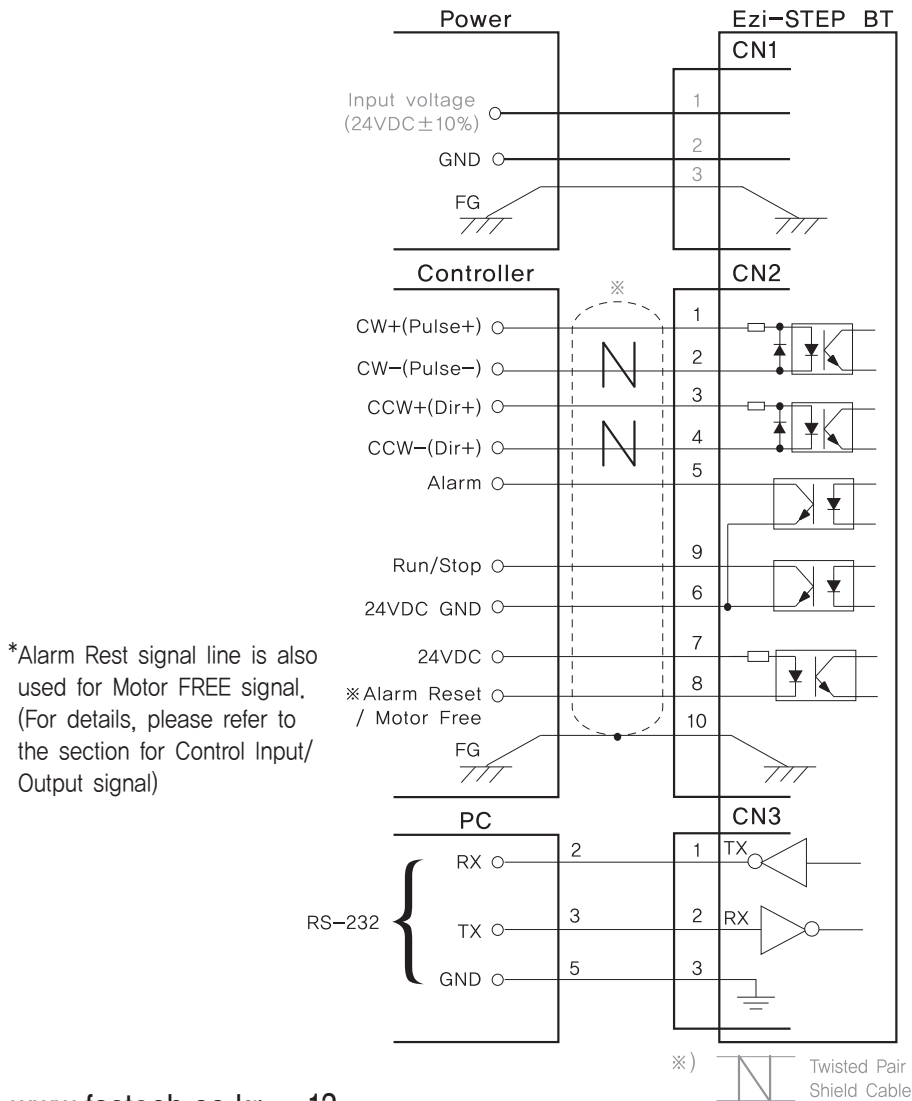

## Ezi-STEP-BT-86 Series

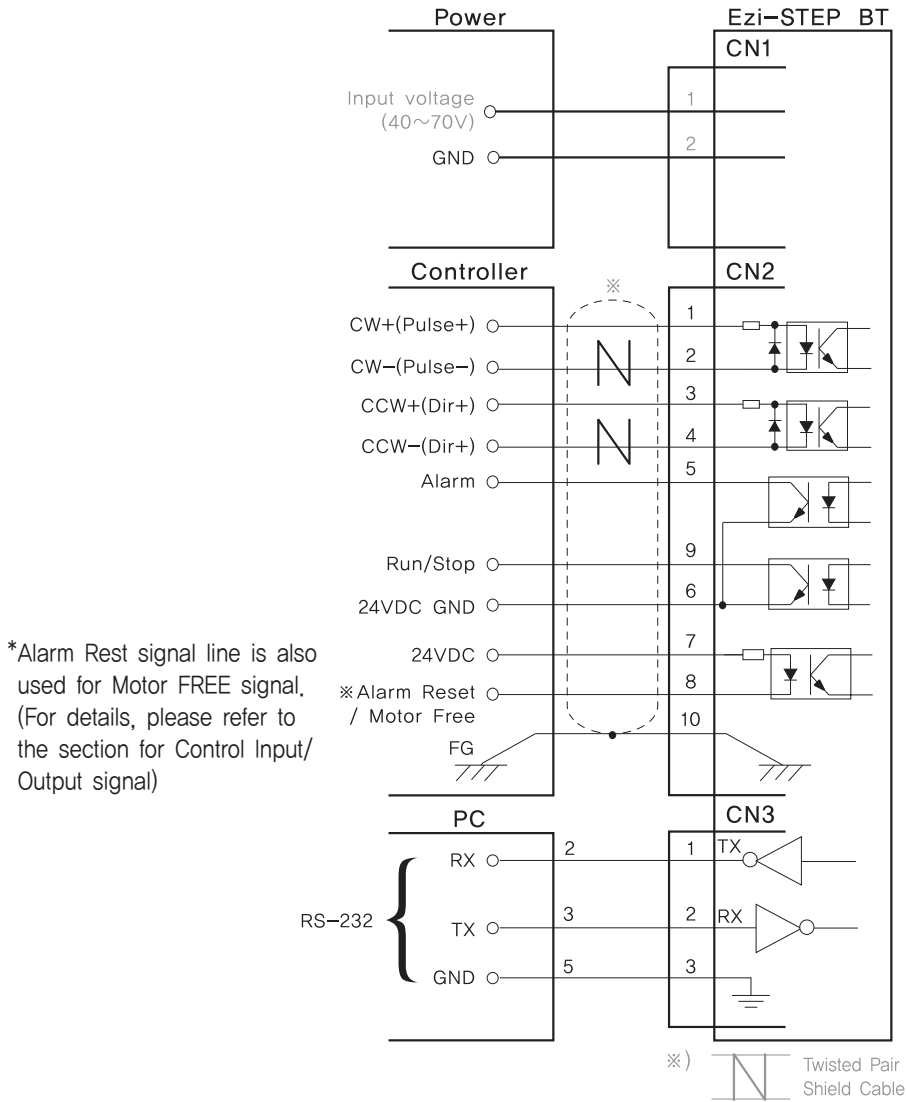

## 6. Setting and Operation

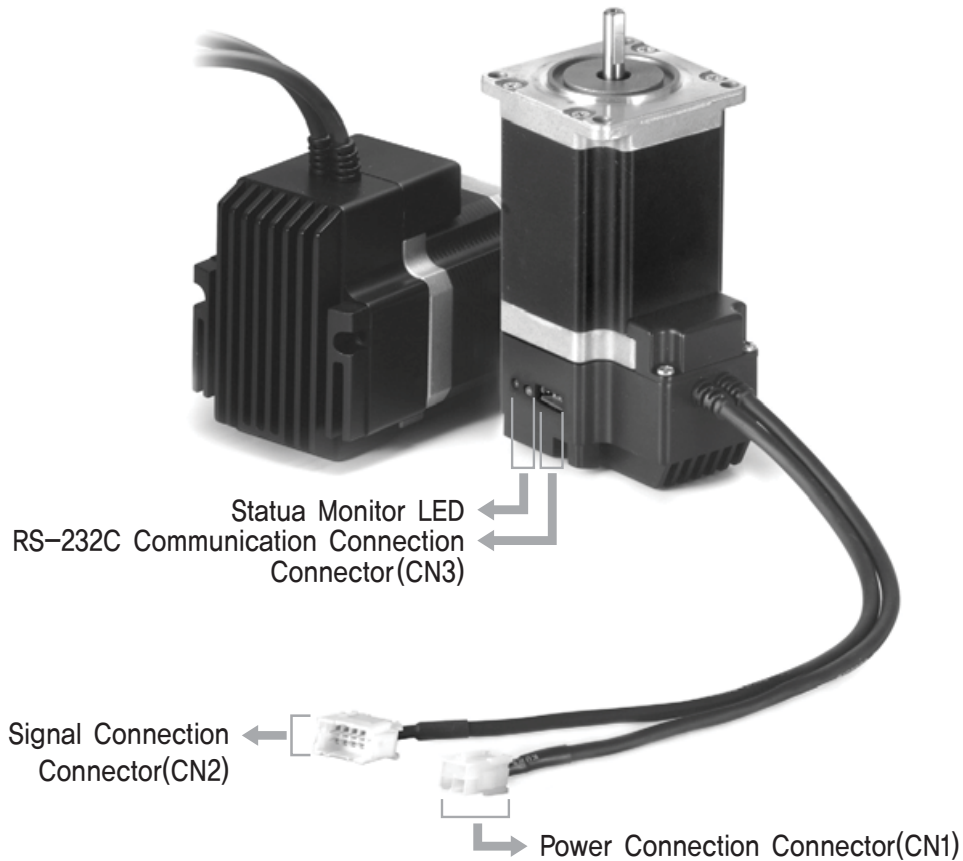

### 6.1 Status Monitor LED

#### 6.1.1 Status LED Function and Condition

indication	Color	Function	Flash Condition
PWR	Green	Power Input Indication	Lights when power is On Flash when Motor Free status.
ALM	Red	Alarm Indication	Flash when protection function is activated (Identifiable which protection mode is activated by counting the LED flash times)



## 6.1.2 Protection functions and LED flash times

Times	Protection	Conditions
1	Over Current Error	Excessive current flowed into a motor
2	Over Speed Error	Motor speed exceeded 3,000rpm
3	Step Out Error	Abnormally motor do not followed pulsed input
5	Over Temperature Error	Internal temperature of a motor drive exceeded 55°C
6	Over Regenerative Voltage Error	Back-EMF is more high limit value BT-42/BT-56 Series : 50V, BT-86 Series : 70V
7	Motor Connect Error	Power is ON without connection of motor cable to drive
9	Motor Voltage Error	Motor voltage is less than low limit value BT-42/BT-56 Series : 20V, BT-86 Series : 36V
11	System Error	Error occurs in drive system
12	ROM Error	Error occurs in Parameter storage Device(ROM)
14	Input Voltage Error	Power source voltage is out of limited value BT-42/BT-56 Series : 20~28V, BT-86 Series : 40~70V



Alarm LED flash  
(ex: Step out)

## 6.2 Power Connection Connector(CN1)

NO.	Function	Pin Layout
1	Input Power : +24VDC	
2	Input Power : GND	
3	F. GND	
4	NC	

※Only for BT-42, BT-56 Series.

NO.	Function	Pin Layout
1	Input Power : 40~70VDC	
2	Input Power : GND	

※Only for BT-86 Series.

### 6.3 Signal Connection Connector(CN2)

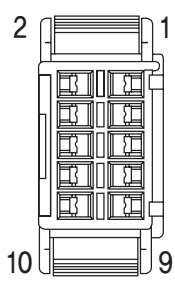
NO.	Function	Input/Output	Pin Layout
1	CW+(PULSE+)	Input	
2	CW-(PULSE-)	Input	
3	CCW+(DIR+)	Input	
4	CCW-(DIR-)	Input	
5	ALARM	Output	
6	GND	Input	
7	+24VDC	Input	
8	ALARM RESET	Input	
9	RUN/STOP	Output	
10	F. GND	-----	

### 6.4 Communication Connection Connector(CN3)

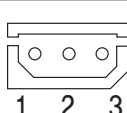
NO.	Function	Input/Output	Pin Layout
1	Tx	Output	
2	Rx	Input	
3	GND	-----	

## 7. Setting Up Parameters

### 7.1 Setting Up Parameters

RS-232C serial communication port of a computer is used to set up various parameters of the motor drive. The set-up program is supplied with the product on a companion CD. It is recommended to make a copy of the program in any folder on your computer. Then please execute the program, named "Ezi-STEP BT Setting.exe", from the folder.

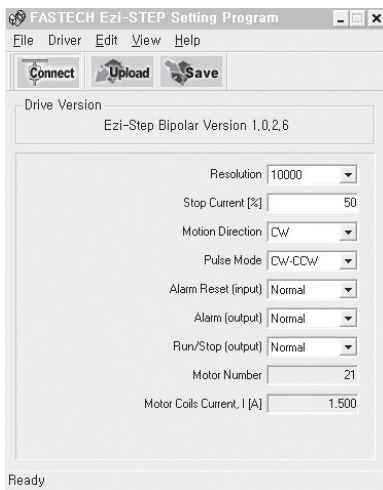

: Please select an appropriate Prot No. and press  button. Then it will display the various parameter values previously stored in the drive.

#### ※ Error Message

There is no response. (You may select wrong baudrate of wrong port no.)

- ① Select wrong Port No.
- ② Select already used Port No. in other program.
- ③ Communication cable is not connected.
- ④ Power is not supplied to drive.





: Display the parameter values stored in the drive.



: Save the parameter values displayed on the screen into the drive.

### 7.2 Resolution Selection

Resolution means the number of pulses per one rotation of a motor.

Select a desired resolution by pressing  in  button on Ezi-STEP BT Setting screen. The possible resolution values are 500~50,000.



Press button to save the value selected into the drive.

※ The default factory setting is 10,000[Pulses/Revolution].

## 7.3 Stop Current Selection

Stop Current means the motor current value automatically set in 0.1 sec after motor stops. This is to prevent the overheat of a motor when the motor is under long time idling. Select a desired Stop Current by pressing in   button on Ezi-STEP BT Setting screen. The range of this value is 10~100 and the unit is a percentage.



Press button to save the value selected into the drive.  
 ※ The default factory setting is 50%.

## 7.4 Rotational Direction Selection

The direction of the motor rotation can be selected either in CW(Clockwise) or in CCW(Counter Clockwise). Select a desired rotation direction by pressing  in   button on Ezi-STEP BT Setting screen.



Press button to save the value selected into the drive.  
 ※ The default factory setting is CW(Clockwise).

## 7.5 Pulse Input Selection

As the Pulsed inputs, a user can choose One-pulse-mode(Pulse/Dir) or two-pulse-mode(CW/CCW). Select a desired pulse mode by pressing  in   button on Ezi-STEP BT Setting screen.



Press button to save the value selected into the drive.  
 ※ The default factory setting is two pulse input mode(CW/CCW).

## 7.6 Alarm Reset Input Selection

Input method of Motor Free/Alarm Reset can be selected. Select a desired method by pressing  in   button on Ezi-STEP BT Setting screen.



Press button to save the value selected into the drive.  
 ※ The default factory setting is Normal.

※ Caution : When you select 'Inverse' :

It can be 'Motor Free' status when power is applied to Ezi-STEP BT during Signal Connector(CN2) is not connected. The power LED(green) is flash to show the status of 'Motor Free'

## 7.7 Alarm Output Selection

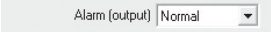

Alarm signal output method can be selected when error happens. Select a desired method by pressing  in  button on Ezi-STEP BT Setting screen.



Press button to save the value selected into the drive.

※ The default factory setting is Normal.

## 7.8 Run/Stop Output Selection

Run/Stop output method can be selected that indicate the motor running status. Select a desired method by pressing  in  button on Ezi-STEP BT Setting screen.



Press button to save the value selected into the drive.

※ The default factory setting is Normal.

## 7.9 Motor Number, Motor Coils Current

This parameter can not be changeable. The information of Motor Number is needed for A/S of drive.

Motor Number	<input type="text" value="21"/>
Motor Coils Current, I [A]	<input type="text" value="1.500"/>

## 8. System Configuration

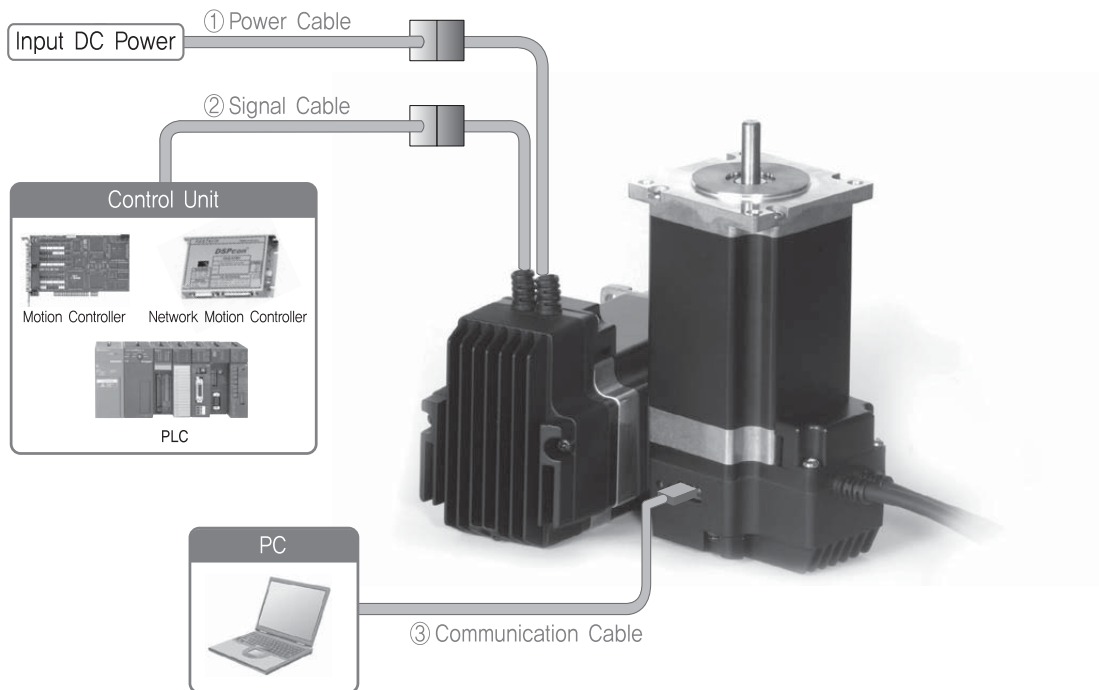

※Standard cable length of Power and Signal is 30cm, Extension cable is needed to extend this limitation.

### 8.1 Option

#### ①Power Cable

Available to connect between Power and Ezi-STEP BT.

Item	Length[m]	Remark
CBTS-P-□□□F	□□□	Normal Cable
CBTS-P-□□□M	□□□	Robot Cable
CBTL-P-□□□F	□□□	Normal Cable for BT-86
CBTL-P-□□□M	□□□	Robot Cable for BT-86

□ is for Cable Length, The unit is 1m and Max, 2m length.

#### ②Signal Cable

Available to connect between Control Unit and Ezi-STEP BT.

Item	Length[m]	Remark
CBTS-S-□□□F	□□□	Normal Cable
CBTS-S-□□□M	□□□	Robot Cable

□ is for Cable Length, The unit is 1m and Max, 20m length.

#### ③Communication Cable

Available to connect between PC and Ezi-STEP BT. This is used for change setting value of Resolution and STOP Current etc.

Item	Length[m]	Remark
CBTS-C-□□□F	□□□	Normal Cable

□ is for Cable Length, The unit is 1m and Max, 15m length.

## 9. Control signal Input/Output Description

### 9.1 Input Signal

Input signals of the drive are all photocoupler inputs. The signal shows the status of internal photocouplers [ON: conduction], [OFF: Non-conduction], not displaying the voltage levels of the signal.

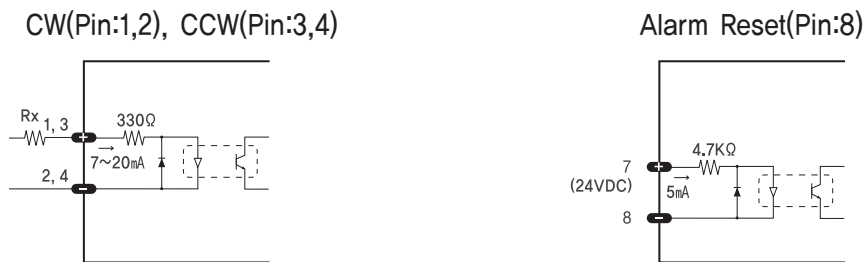

#### ◆ CW, CCW Input

This signal can be used to receive a positioning pulse command from a user-side host motion controller. A user can select 1-pulse input mode or 2-pulse input mode. The input schematic of CW, CCW is designed for 5V TTL level. When using 5V level as an input signal, the resistor Rx is used and connect to the drive directly. When the level of input signal is more than 5V, have to add Rx. If this resistor is absent, the inner schematic can be broken. In input signal level is 12V case, Rx value is 680ohm and in 24V case, 1.8Kohm is suitable for Rx value.

#### ◆ Motor Free Input

This input can be used only to adjust the position by manually moving the motor shaft from the load-side. By setting the signal [ON], the drive cuts off the power supply to the motor. Then, one can manually adjust output position. When setting the signal back to [OFF], the drive resumes the power supply to the motor and recovers the holding torque. When driving a motor, one needs to set the signal [OFF]. In normal operations set the signal [OFF] of disconnect a wire to the signal.

#### ◆ Alarm Reset Input

When a protection mode has been activated, a signal to this Alarm Reset input cancels the Alarm output. By setting the alarm reset input signal [ON], cancel Alarm output. Before cancel the Alarm output, have to remove the source of alarm.

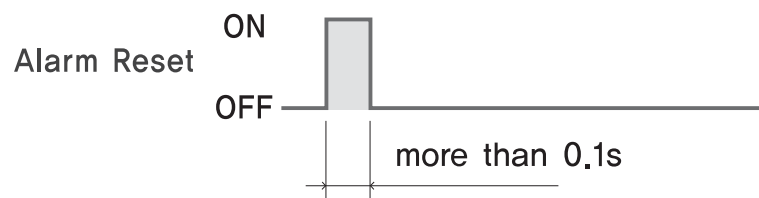

**[Caution]** If Alarm Reset input signal still remains [ON], motor will be Free state. Keep in mind to change [ON]→[OFF] state. It operates reversely compare to Normal mode, when you set inverse mode.

## 9.2 Output Signal

As the output signal from the drive, there are the photocoupler outputs(Alarm, Run/Stop). The signal status operate as [ON: conduction], [OFF: Non-conduction] of photocoupler not as the voltage level of signal.

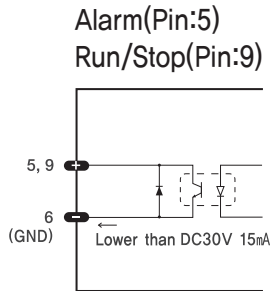

### ◆ Alarm Output

The Alarm output indicates [OFF] when the drive is in a normal operation. If a protection mode has been activated, it goes [ON]. A host controller needs to detect this signal and stop sending a motor driving command. When the drive detects an abnormal operation such as overload or overcurrent of a motor, it sets the Alarm output to [ON], flash the Alarm LED, disconnects the power to a motor, and stops the motor, simultaneously.

### ◆ Run/Stop Output

Run/Stop Output state is [ON] when motor positioning is completed. It operates reversely compare to Normal mode, when you set Inverse mode.

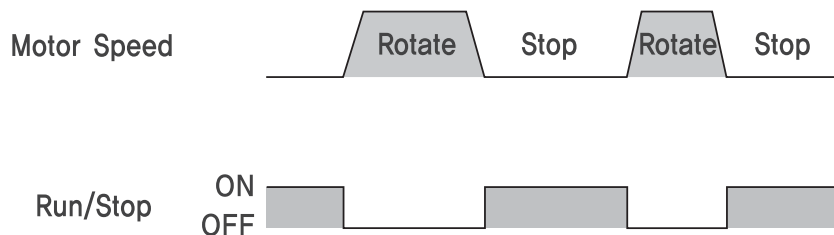



## Appendix

### ■ Cable for RS-232C

For cable extension between PC and Ezi-STEP BT drive.

#### WIRING DIAGRAM

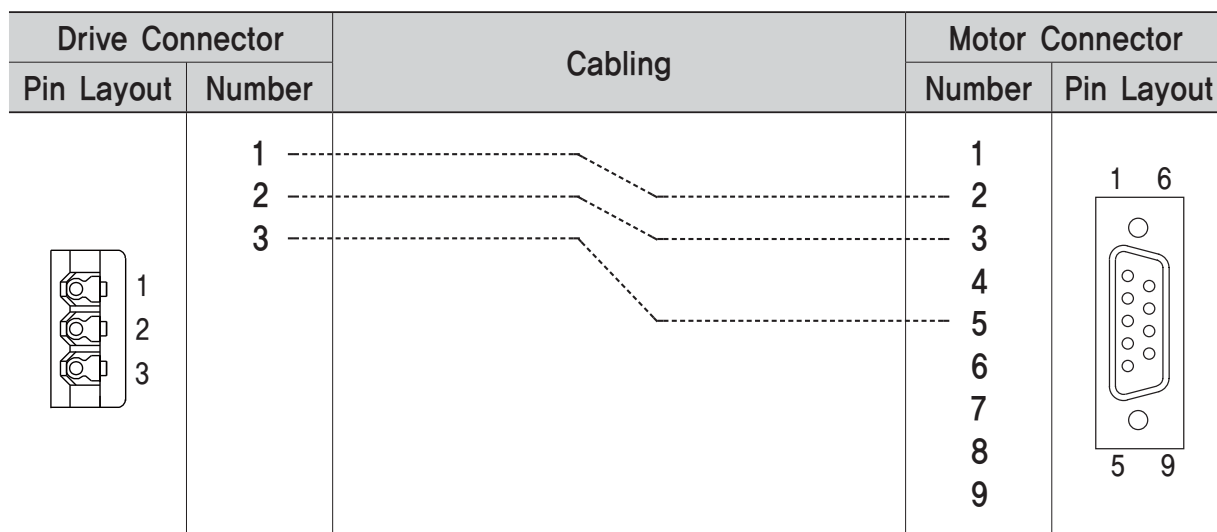

### ■ Connector

Connector specifications for cabling to Ezi-STEP BT.

ITEM		Part Number	Maker	
Power (CN1)	BT-42 Series	Connector Housing	5557-04R	MOLEX
	BT-56 Series	Terminal	5556T	MOLEX
	BT-86 Series	Connector Housing	3191-2R	MOLEX
		Terminal	1381T	MOLEX
Signal(CN2)		Connector Housing	XADRP-10V	JST
		Terminal	SXA-001T-P0.6	JST
RS-232C (CN3 : Drive Side)		Connector Housing	5264-03	MOLEX
		Terminal	5263	MOLEX
RS-232C (CN3 : PC Side)		D-SUB(9PIN) Connector	717SD-ESD9S	AMPHENOL
		Backshell	17E-1657-09	AMPHENOL

※These connectors are serviced together with Ezi-STEP BT except when purchasing cables as an option.

※Above connector is the most suitable product for Ezi-STEP BT. Another equivalent connector can be used.

▪ MEMO

▪ MEMO



*Fast, Accurate, Smooth Motion*

**FASTECH Co., Ltd.**

Rm #1202, Bucheon Technopark 401 Dong, Yakdea-dong,  
Wonmi-Gu, Bucheon-si, Gyeonggi-do, Rep. Of Korea (Zip)420-734  
TEL : 82-32-234-6300,6301 FAX : 82-32-234-6302  
E-mail : fastech@fastech.co.kr Homepage : www.fastech.co.kr

- Please note that the specifications are subject to change without notice due to product improvements.

© Copyright 2007 FASTECH Co., Ltd, Jan 13, 2014 Rev.02